



Est. USA 1981

[www.AKCP.com](http://www.AKCP.com)

# SPX+ Introduction Manual





## Table of Contents

Introduction .....	4
Specifications .....	7
SPX+ Modules .....	8
Expansion architecture .....	11
Port assignment information for SPX+ units .....	12
LED information for SPX+ units .....	13
Reset button functions for SPX+ units .....	14
Setting up the unit's IP address .....	15
SPX+ Web UI Walkthrough.....	17
Menu navigation.....	18
Monitoring Summary page.....	18
Graph feature.....	20
Expansion units .....	22
Managing Desktops and Maps .....	23
Important Notes on custom desktops .....	24
Managing Desktops .....	25
Navigation.....	25
Folders .....	27
Desktops.....	28
Adding items to your custom desktop .....	31
Desktop Auto Scroll feature.....	32
Managing Rack Maps.....	33
Access Control Users and Groups .....	35
Notifications and Events, Sensors menu, Settings menu .....	36
System page .....	37
General .....	37
Language management.....	39
Date/Time .....	43
Network.....	44
Modem.....	45

VPN .....	47
Set up VPN connection to APS.....	48
SMTP .....	52
SNMP .....	54
Server Integration .....	56
Services .....	57
SSL Certificate.....	58
Modbus .....	61
Password Checking and security.....	62
Password Security options.....	63
Maintenance .....	66
Heartbeat Messages .....	68
License Management.....	69
About.....	71
Sensors page.....	72
General options for all sensors .....	74
Virtual sensors .....	77
Dry Contact sensors .....	79
Connecting to the Dry Contacts.....	80
Configuring the Dry Contact Sensor.....	80
Isolated Dry Contact details.....	82
Dry Contact module types .....	83
Example sensor configuration .....	84
Temperature/Humidity Sensor.....	84
Relay Sensor .....	88
Pulse Counter Sensor.....	92
Firmware upgrade through the Web UI.....	95
Network ports used by SP+ units .....	97

## Introduction

In this manual, we'll cover the main features and basic configuration of the SPX+ and the setup of notifications and the explanation of events will be in another manual.

### What is the SPX+?

sensorProbeX+ is the latest generation of sensorProbe devices. In a completely new form factor that allows for 1U, 0U and DIN rail mounting with a low profile design it takes up much less cabinet space. SPX+ comes in several standard configurations, but with the AKCP configuration tool you are able to custom design a unit to your own specifications. Choose from various modules to specify the number of dry contacts, sensor ports or an internal modem.

Please check our SPX+ unit configurator tool on our website, where you can build your own custom configuration:

<http://www.akcp.com/configuratorTool/>

You can also view our SPX+ video on our YouTube channel:

<https://youtu.be/8ACjfn7PswA>

### SPX+ Features:

- Modular design, 1U, 0U and DIN rail mounting
- IP based, including SNMPv3, HTTPS, VPN
- Send encrypted SNMP Trap and Email Notifications
- Supports at least 4 Intelligent Sensors, expansion units and up to 120 Dry Contacts
- Optional cellular modem with external antenna
- Notification Wizards
- Front and Rear Thermal Mapping for any server cabinet
- Low Cost Daisy Chained Temperature sensors
- Optional Expansion Module connectivity
- Virtual Sensors
- Patented Fire Suppression feature
- AKCP Swing Handle Lock support
- Optional Dry Contact Sensors in I/O and Opto-Isolated modes

### **Important notes:**

A) Some of the pictures shown in this manual might not represent the actual Web UI of the unit and may refer to the SP2+ unit; this is because the SPX+ is a new family of units and its Web UI is basically all the same as SP2+. We are constantly working on improving the firmware; please provide us with feedback if you have any issues configuring your unit.

B) All units are shipped with the **default web interface fixed IP address of 192.168.0.100**. We strongly recommend you change this to avoid problems with duplicate IP addresses on your network. Please see the section in this manual on how to setup a new IP address on the unit.

C) AKCP also always highly recommends using a **dedicated 3rd party UPS on the units**. Any damage caused by unstable power or power outages *will void the warranty* on our units.

**Hardware installation remark:** It is recommended to connect the power supply's cable prior to mounting the unit in the rack; otherwise it might be hard for you to connect it while it's mounted.

### **What's the difference between the SP2+ and SPX+?**

The SP2+ has 4 sensor ports for connecting any compatible AKCP sensor. With the Expansion option it has 3 sensor ports and 1 expansion port.

The SPX+ also supports expansion modules and has modular design allowing you to choose your own configuration.

We have several standard configurations, but with the AKCP Configuration Tool you are able to custom design a unit to your own specifications. See below for available modules to choose from.

### **What's the difference between F4 (older) and F7 (newer) processor versions?**

The F4 SP+ & the F7 SP+ processors - or as we will refer to them as platforms are different.

The new F7 processor or platform supports more memory on the SP+ (SP2+ and SPX+) units, thus more features. Future firmware development will concentrate on the F7 units and F4 units won't get new features.

The most notable difference between the platforms is the supported number of sensors when the VPN feature is enabled: the total sensor count is reduced to 36 on F4 units, but it is still 150 on F7 units.

When upgrading the firmware, there are two separate .bin files included in the firmware update package. One for the F4 units and one for the F7 units.

If you try to upgrade your unit with the wrong .bin file, the firmware upgrade will fail. So please make sure you use the correct file for your unit type following the firmware upgrade instructions in the text file that is included in the compressed firmware package.

Also very important to note that any backup configuration created on the F4 platform cannot be uploaded to the F7 platform unit and vice versa.

In the SP+ units web UI you will be able to view which platform the unit is using.

This can be checked in the Settings >> General page >> System Description:



**General**  
System / General

**System Description** SP2+ F7 1.0.4946 May 27 2019 15:37:34

And in the Settings >> About page >> System Description:

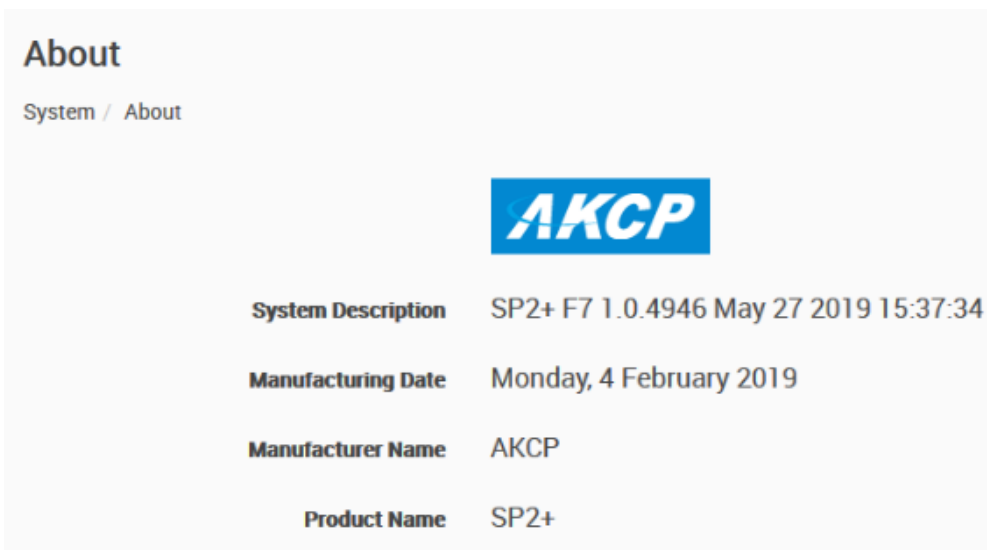

**About**  
System / About



<b>System Description</b>	SP2+ F7 1.0.4946 May 27 2019 15:37:34
<b>Manufacturing Date</b>	Monday, 4 February 2019
<b>Manufacturer Name</b>	AKCP
<b>Product Name</b>	SP2+

## Specifications

**Dimension:** 44 (W) x 46 (H) low profile design

**Supports connection of:** Modbus RTU, E-Sensor8, E-Opto16 and CCU Expansion modules through optional EXP port and BEB port

**Mounting:** 0U Toolless rack mount, optional wall mount brackets, horizontal 1U mounting or DIN rail brackets

**Power:** External 5V 2A Power Adapter, Input Voltage and Current ratings: 100V~240V - 0.22A, Optional internal power supply

**Status Indication:** LED indication for power, network connectivity sensor online and threshold

**Components:** Manufactured using highly integrated, low power surface mount technology. All units undergo a minimum 48 hour burn in cycle to detect in fact mortality.

**Operating Environment:** Temperature: Min. -35° C – Max. 70° C, Humidity: Min. 20% – Max. 80% (Non-Condensing)

**MTBF:** 1,400,000 Hours based on field experience with sensorProbe units.

**Base Unit:** 4x Sensor Ports for connecting AKCP sensors or swing handle cabinet locks, 1x Expansion Out Port (Optionally used for Modbus), 1x BEB port, 1x 10/100 Ethernet Port

**Max Sensors:** Maximum of 150 onlined sensors, including Expansion Units and virtual sensors (if VPN is enabled - reduced to 36 on F4 units, 150 on F7 units)

## SPX+ Modules

The below modules can be added to the standard configurations to build up the device with what you need. For example, if you wish to have 12 sensor ports, you can order an SPX8 and an additional sensor4 module. You can also build your unit using our online Configuration Tool (<https://www.akcp.com/configuratorTool/index.html>) to check that it fits in 1U or 0U rack mounting. If you exceed 1U then there is the option to continue the configuration on an additional U connected via BEB to the base unit.



### sensor4 (S)

Additional sensor ports can be added to the base SPX+ module in blocks of 4. The sensor4 modules are compatible with all AKCP intelligent sensors. Build a cost effective monitoring platform, able to monitor multiple cabinets from a single IP address.



### dry10/20

Use Dry Contacts for monitoring a variety of third party devices, door contact sensors, digital outputs from UPS, control panels and alarm panels. Use IO Dry Contacts to actuate responses to inputs.

The 10x or 20x Dry Contacts module is available in 3 configurations:

- Configurable I/O dry Contact (0VDC/5VDC)
- Input only 5V Dry Contact, opto-coupled input
- Isolated input Dry Contact, from 5V to 20V voltage input signal



### Cellular Modem and Optional GPS

The cellular data modem module gives the SPX+ ability to communicate over a cellular data network. An external antenna ensures a good signal can be received even if the SPX+ is inside a cabinet. Send SMS alerts directly from the SPX+ device, or connect it to our central monitoring platform, AKCPro Server, via a VPN connection. Cellular modems are available in European and US bands, and in 3G or 4G versions. Optional GPS antenna can be added for geolocation of the device.





#### 4x Analog to Digital inputs (4x 0-5VDC Input)

This module is ideal for connecting third party analogue sensors with a 0-5VDC scale output. Many industrial sensors are available with this scale output, opening up the possibilities of monitoring many different sensors not provided by AKCP.



#### 4x Mini Relays

This module includes 4x mini DC relays. Use them to switch on/off low current devices directly, or use them to drive larger relays. Ideal for systems and control, building and industrial automation. Contact ratings : 1A 24VDC/120VAC resistive load

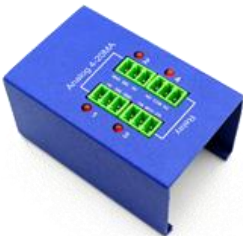

#### 2x Mini Relay and 2x 0-5VDC Input

This module is a combination of the above modules: 2x relays and 2x 0-5VDC Analog sensor inputs.



#### Internal UPS (4x AA rechargeable batteries)

This module is an internal mini UPS backup battery. Using 4x AA rechargeable batteries (not supplied) you can power the SPX+ for up to 30 minutes with the modem, or up to 1.5 hours without. Maintain your monitoring and alerting capabilities even during power outages. Make sure that your SPX+ can continue alerting even if your network and power is down by combining the mini internal UPS with cellular data modem.

A short video of this module is available here: <https://youtu.be/uis1OShODC8>

**Important Note:** This backup internal power supply DOES NOT protect against unstable power or power surges, so we still highly recommend using a dedicated third party UPS between the AC power and the SPX+ 5VDC power adapter. As a reminder damage due to unstable or power surges will void the warranty on the units.

## Ball Valve Control Module

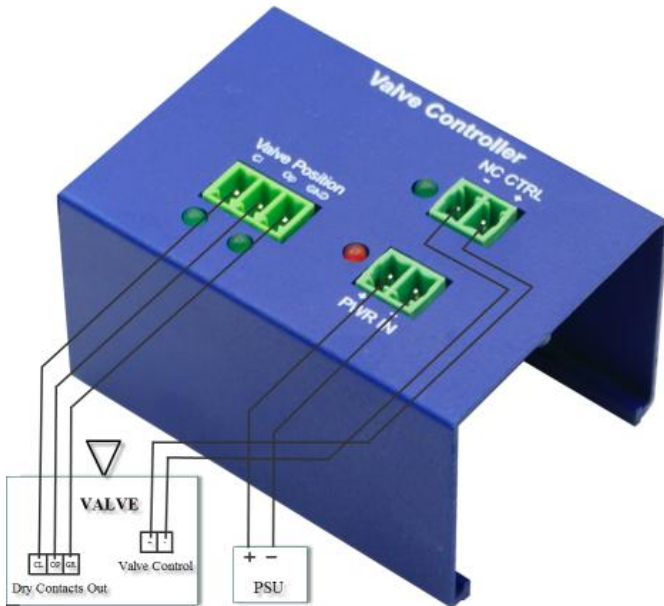

If you have DC motors or electronically controlled ball valves which require polarity reversal to turn in the opposite direction, this module is applicable. Ideal for water irrigation or industrial applications which require valve and motor controls.

**Important:** this module is only supported on F7 units

Turning the relay On / Off will set the opened / closed state on the Valve Status. Timeout for opening and closing are configurable in the Web UI (value range: 1-600, 10 s by default). If this module is used with a valve that cannot provide open and closed status, the Valve Status sensor can be set to offline.

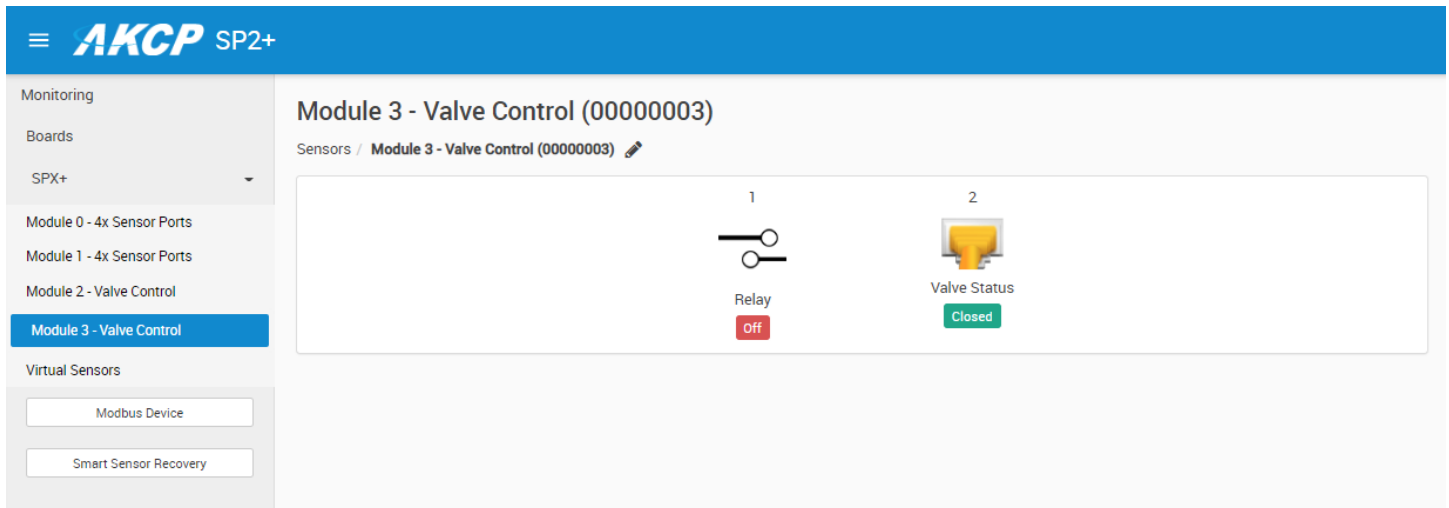

### Statuses of Valve Status sensor:

- Unknown: status when the valve is not in opened or closed state when it is not operating (opening/closing).
- Opening: operating status when the relay is set to ON.
- Closing: operating status when the relay is set to OFF.
- Error: status when the valve is considered to have an error:
  - Not opened or closed after operating for a period of time.
  - Valve opened and closed are detected at the same time.
- Opened: status when open valve is detected.
- Closed: status when closed valve is detected.

## Expansion Architecture

Every SPX+ comes with both EXP (Expansion) and BEB (Basic Expansion Bus) ports. These expansion ports give you the ability to add functionality to your base device, so your system can grow with your needs.

### Basic Expansion Bus (BEB)

BEB is suitable for short distance expansion within your cabinet. Build up your system adding additional SPX+ BEB Remote units. Daisy chain the expansion units up to a maximum of 18 meters for the total chain. SPX+ BEB Remote units are cost effective expansion when you place the unit within the same or neighboring cabinet. Please refer to our separate BEB manual for more information.

### Expansion (EXP)

EXP is used where you need to extend the distance up to 300 meters. SPX+ EXP Remote devices can be daisy chained, with a maximum of 300 meters between each unit.

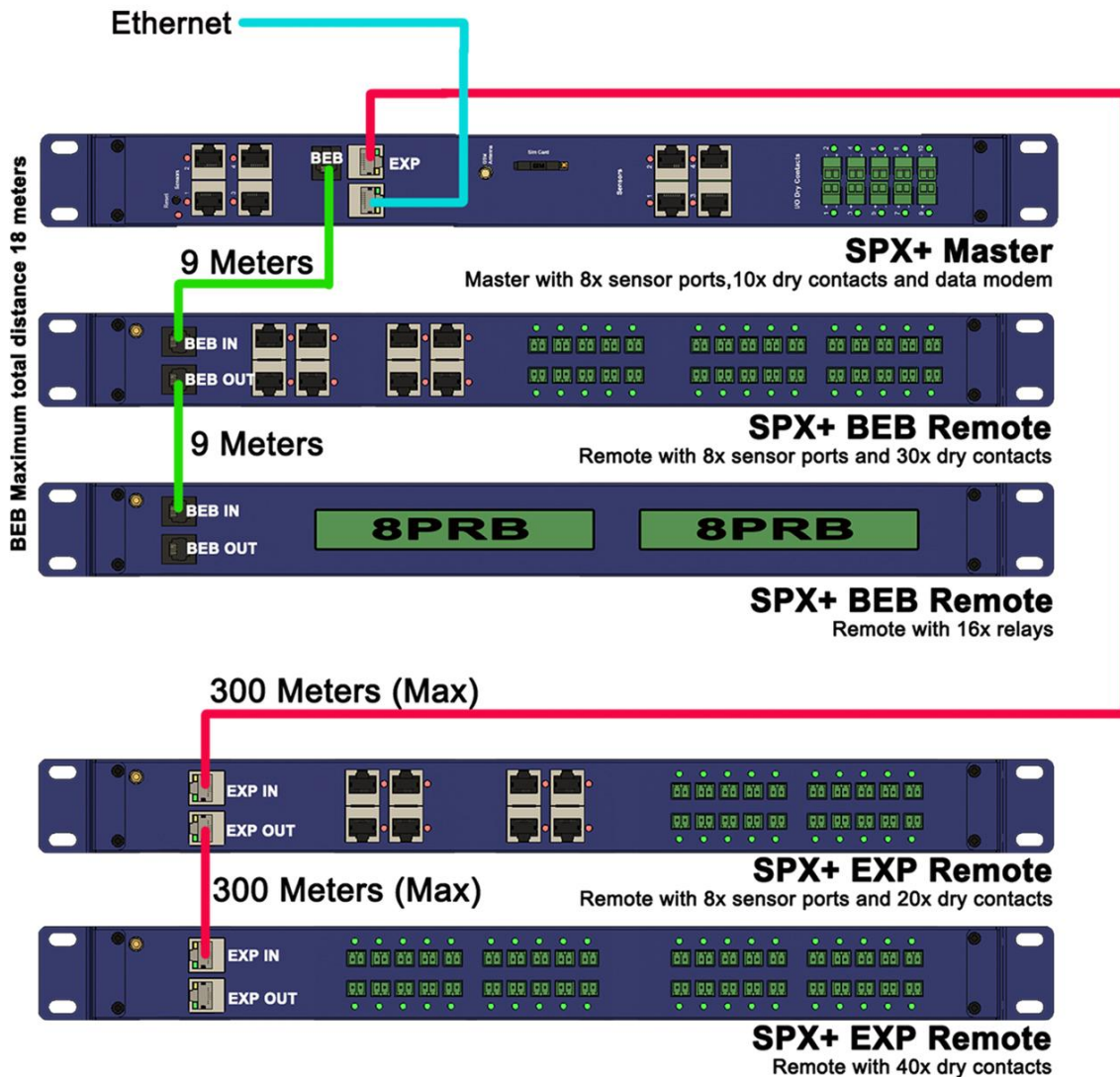

## Port assignment information for SPX+ units

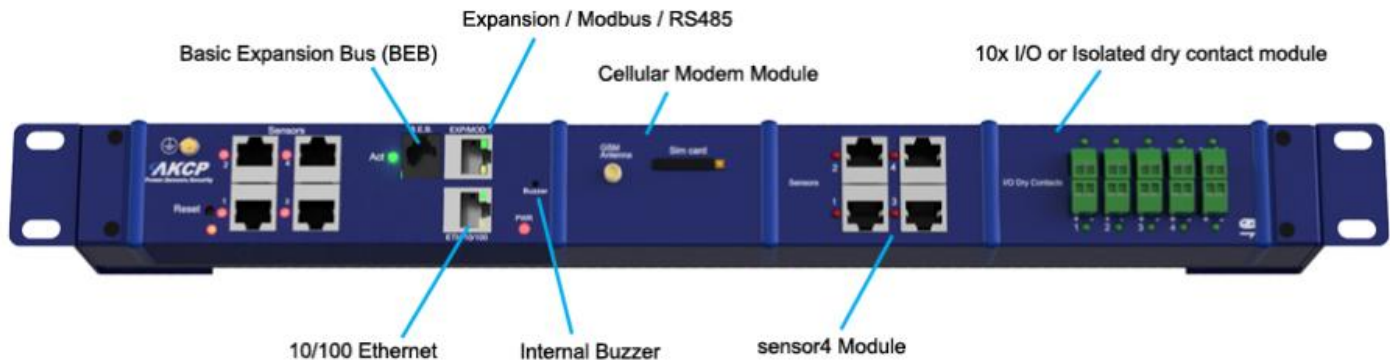

### 4x intelligent sensor ports

Every SPX+ comes with 4 intelligent sensor ports. Connect a wide range of AKCP's intelligent sensors to monitor environmental and security conditions in your cabinet. Thermal map sensors help identify hotspots, smoke alarms detect fire hazards or swing handle RFID cabinet locks protect against unauthorized access. You may connect AKCP intelligent sensors to any available ports.

### Expansion & BEB port

Connect additional remote BEB units, or E-Sensor8 / E-Opto16 expansion units to increase the capabilities and number of sensors your SPX+ can monitor.

*Important:* On the expansion port you cannot connect AKCP sensors; it's only for the expansion units.

### Cellular modem

For remote site locations, or those places without a WAN network connection an internal 3G/4G GSM modem can be installed to give 24/7 connectivity. Make sure you are always up to date and know your site status, or send SMS alerts directly from the SPX+.

### Additional sensors with sensor4 Module

With the optional 4x intelligent sensor ports you can connect more of AKCP's range of environmental and security monitoring sensors, such as thermal maps, RFID electronic swing handle locks, airflow sensors and more. **Maximum sensors 150. If the VPN feature is enabled: 36 total sensors for F4 units, 150 on F7 units.**

### Dry contacts

Monitor a variety of devices and alarm panels with dry contact inputs. Available in 5VDC input, I/O and isolated configurations. LED indicators show the status of each individual dry contact.

**Important note:** If you're using analog pins on the sensor ports (with manually on-lined DCV sensors, and pin 7 of the RJ45 connector) make sure that the **voltage doesn't exceed 3 Volts**. Otherwise you can damage the unit!

## LED information for SPX+ units

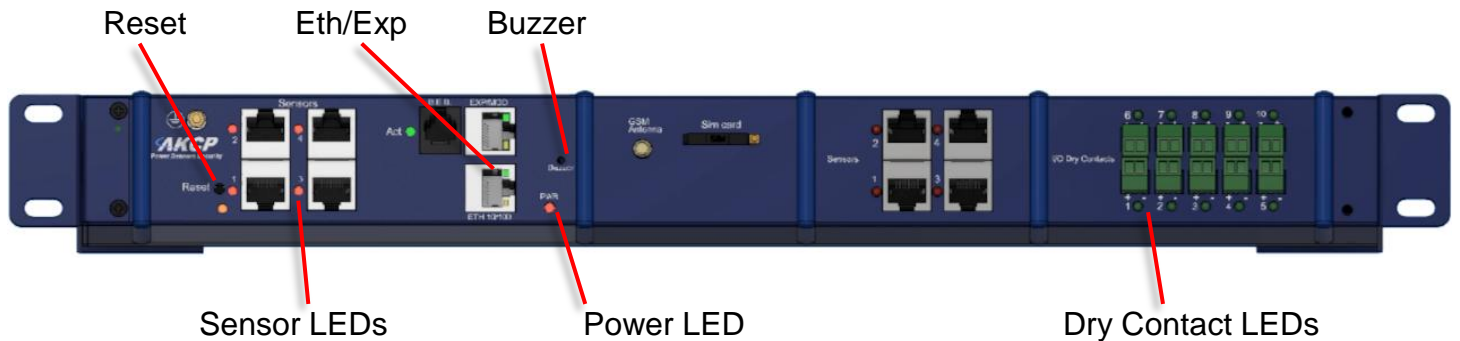

The **Ethernet/Expansion LEDs** have standard indication LEDs for network activity and connection state (green and orange).

The **Power LED** is red, simply on or off.

**Sensor LEDs** (red) and **Dry Contact LEDs** (green) can have different states:

Off = offline

On = online and normal

Slow blinking = Warning status

Fast blinking = Critical and Error status

The **Buzzer** can provide audible notifications for sensor statuses. Please check our separate SP+ Buzzer manual for using this feature.

The **Reset button** functions are described below.

## Reset button functions for SPX+ units

There are specific commands you can send to the unit by holding the Reset button for a specified amount of time.

You'll have to use something sharp, such as a straightened paperclip to be able to press Reset.



Commands:

Time to hold	Action
< 3 sec	Speak/show IP and broadcast its info (display on LCD sensor too, if connected)
3..7 sec	Reboot (reset CPU)
7..12 sec	Web UI password reset
12..17 sec	Clear the sensor, notification and access DBs, logs Serial flash erase (DB erase without factory reset, the system configuration is kept)
17..25 sec	Reset to factory defaults (serial flash erase + config erase)
> 25 sec	No action (useful when the button was pressed by mistake)

Notes:

- When the Reset button is held for longer than 12 seconds (DB erase) and then released, the Sensor Port 1 and 2 LEDs will give a visual indication of the state of database erase (the reboot and password reset doesn't have visual indication).
- When the button is held longer than 17 seconds (factory reset) and then released, these sensor port LEDs will be blinking fast and alternate during the factory reset mode.

## Setting up the unit's IP address

Very Important Note: The unit's ship with the passwords **enabled**. The default log in for the web interface is Username: *admin* Password: *public*

Every unit is shipped with the default IP address of **192.168.0.100**

First we will go through the process of changing this IP address to fit your own network configuration.

*Note:* In some cases your computer might not be able to connect to this default IP address. In this situation you either need to:

- a) add this IP your computers routing table or
- b) add a secondary IP address to the LAN card to allow access to the unit.

See below how to setup these.

Ensure the following items are available to you before starting:

- RJ45 CAT5 crossover cable with RJ45 male connection
- A PC with Ethernet card or LAN socket, logged in with Administrator rights

**1)** Connect the unit via the Ethernet port of the unit to your computers LAN or Ethernet port with a CAT5 crossover cable.

**2)** Open a web browser and type the default IP address, hit enter.

You'll be presented by the **Summary** page.

Go to the **System/Network** page to change the network settings (see below in this manual).

Once you have assigned the new IP address use the "ping" command to test the unit's reply.

## How to add a manual route to the computer's routing table?

Open an Administrator Command Prompt (CMD) window and type:

```
route add 192.168.0.100 10.1.1.20
```

Where 10.1.1.20 is the IP address of the Ethernet interface on the PC that the unit is plugged into with the crossover cable.

*Note:* If you do not receive an 'OK!' message then a parameter was wrong or missing. The route is not persistent (removed upon rebooting), but you can also delete it with the `route delete 192.168.0.100` command.

## How to add a secondary IP address to the computer's LAN card?

You can do this via the GUI by opening the LAN connection's properties:

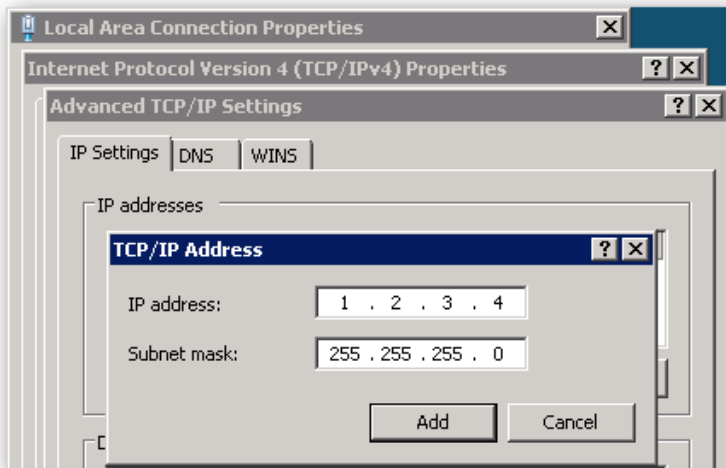

Or open an Administrator Command Prompt (CMD) window and type:

```
netsh interface ipv4 add address "Local Area Connection" 192.168.0.2  
255.255.255.0
```

The above command adds the IP Address 192.168.0.2 (with Subnet Mask 255.255.255.0) to the connection titled "Local Area Connection".

You will then be able to connect to the unit with its default IP.

*Note:* The secondary IP address is permanent for the LAN connection; don't use it if you only need it once. Instead use the routing table method above.



## SPX+ Web UI Walkthrough

### Menu navigation

With newer firmware (after 1.0.3074), the Web UI and the menu structure has been changed on all SP+ family devices.

To open the menu, click on the three horizontal lines in the upper left corner:

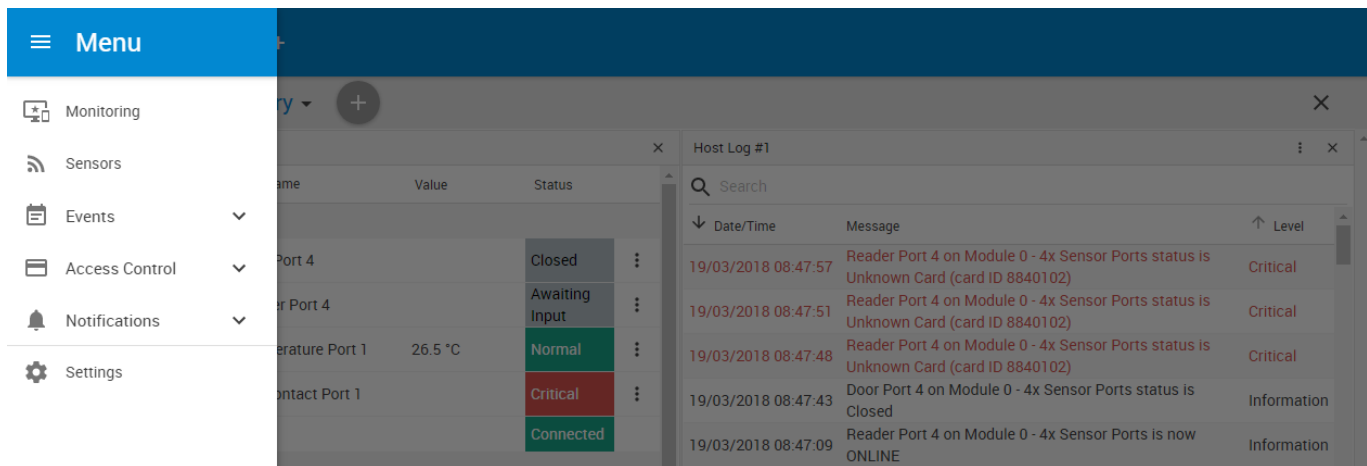

This will bring up the full menu for navigation.

Depending on the device, you might see additional menu items, such as Power.

**Important Note**:- As Microsoft no longer supports the Internet Explorer web browser, we also do not support any version of IE when viewing our web interface on all AKCP base units. Please use the Chrome or Firefox browsers when viewing the base units web UI.

## Monitoring Summary page

Monitoring

≡ **AKCP** SPX+

← Workspace > + Summary ×

🔍 Search

+ System Name (10.1.1.183)

- Gateway

- Module 0 - 4x Sensor Ports

Differential Temp (bottom) Port 3

Differential Temp (middle) Port 3

Differential Temp (top) Port 3

Humidity front (middle) Port 3

Humidity rear (middle) Port 3

Scott's PC Power

Sensor Status Light Port 4

Temperature front (bottom) Port 3

Temperature front (middle) Port 3

Temperature front (top) Port 3

Temperature Port 1

Temperature rear

🔍 System Name (System Location)

↑	Unit	↑	Name	Value	Status	×
<b>SPX+</b>						
-	Module 0 - 4x Sensor Ports		Differential Temp (bottom) Port 3	0.4 °C	Low Critical	⋮
	Module 0 - 4x Sensor Ports		Differential Temp (middle) Port 3	-0.2 °C	Low Critical	⋮
	Module 0 - 4x Sensor Ports		Differential Temp (top) Port 3	0 °C	Low Critical	⋮
	Module 0 - 4x Sensor Ports		Humidity front (middle) Port 3	64 %	Normal	⋮
	Module 0 - 4x Sensor Ports		Humidity rear (middle) Port 3	65 %	Normal	⋮
	Module 0 - 4x Sensor Ports		Scott's PC Power		PC power on	⋮

🔍 System Name (10.1.1.183)

🔍 Search

↓	Date / Time	Message	↑	Level
	14/06/2018 12:14:34	Admin logged in from IP 10.1.1.23		Notice
	14/06/2018 12:14:27	Admin logged out by timeout		Notice
	14/06/2018 07:40:12	Temperature Port 1 on Module 0 - 4x Sensor Ports is 27.5 °C, status is Normal		Information
	14/06/2018 05:17:10	Temperature Port 1 on Module 0 - 4x Sensor Ports is 30 °C, status is High Warning		Warning
	13/06/2018 14:24:43	Admin logged in from IP 10.1.1.23		Notice
	13/06/2018 07:50:51	Temperature Port 1 on Module 0 - 4x Sensor Ports is 27.5 °C, status is Normal		Information
	13/06/2018 04:56:57	Temperature Port 1 on Module 0 - 4x Sensor Ports is 30 °C, status is High Warning		Warning

🔍 Temperature Port 1

● Live From: 13/06/2018 12:20:06  
To: 14/06/2018 12:20:06

This is the Summary page with Sensor Status and the Event Log, with the Temperature Sensor Graph enabled.

### Host Log

The Host Log contains all entries from the “All Events” category. We’ll explain the different categories in the Notifications manual.

The last 30 entries are shown, but if you’re scrolling down the list, more events (30 more) will be loaded automatically. You can view the full log if you keep scrolling down.

In the Summary page's Sensors Information window you can do the following:

Workspace > Summary +				Host Log #1
System Name (System Location)	Unit	Name	Value	Status
<b>SPX+</b>				
Module 0 - 4x Sensor Ports		Temperature Port 1	26.5 °C	Normal
Module 1 - 20x Dry Contacts IO		Dry Contact Port 1		Critical
Virtual Sensors				Connected
<b>CCU (0D000037)</b>				
CCU 1.2		Cabinet Door Port 1		Forced Open

Click on the configuration menu button directly next to the right of a sensor to access its popup menu.

Sensor Error	View Graph
Normal	Enable Graph
Off	Acknowledge
Connected	Offline
	Settings

Directly acknowledge a sensor's status, and put the sensor offline

Off	Sensor Control
Normal	On
Off	Off
Connected	Toggle Off-On
	Toggle On-Off
	View Graph
	Enable Graph
	Acknowledge
	Settings

Control the relay-type sensors

View Graph
Disable Graph
Acknowledge
Settings

Enable/disable graph data collection per sensor (if they support it), and display the graph display window for the Summary page  
We'll explain the Graph feature in more detail below.

## Graph feature

After you've enabled the data collection for a sensor, you can choose to display specific time intervals of the stored data: hourly/daily/weekly/monthly and custom display interval.

You can also export the recorded data in multiple formats.

**Important:** The maximum number of enabled graphs per unit is 14.

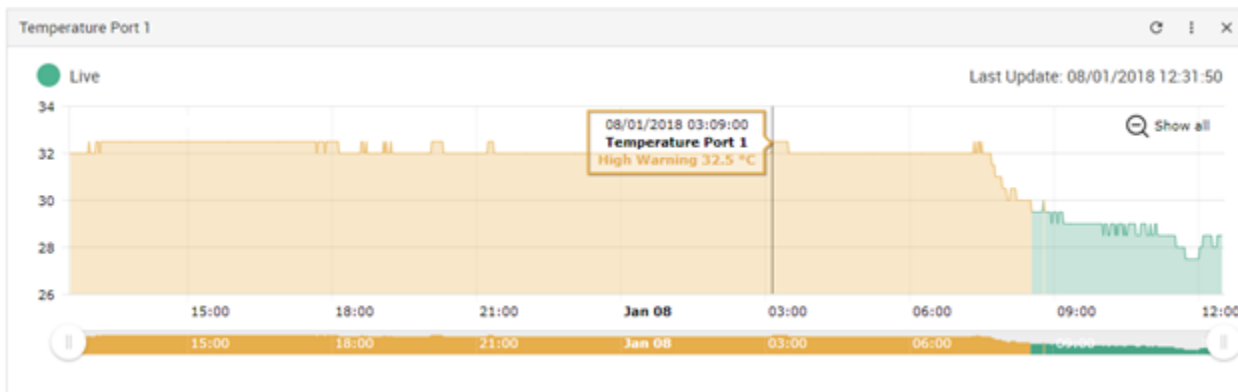

In this example picture, we've chosen to display the temperature sensor's daily maximum.

You could also resize the graph window (including full screen) and move the scale to display more or less data.

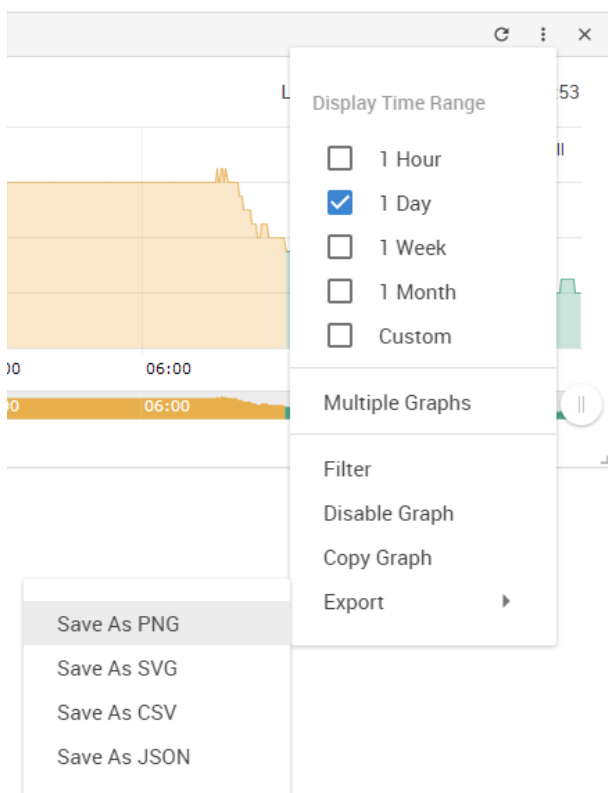

You can choose to export the graph data in selected formats by clicking on the graph's menu on the right, then by choosing the desired format from the popup menu.

The file will be downloaded automatically and assigned a file name that will contain the sensor's name, IP address of the unit, and the date and time.

The graph is always a **Live Graph**; you can set the data collection period in the General Settings page (see below for more information).

You may also refresh the graph data manually with the refresh button on the right.

Graph Data Collection Period  1m 30s  
[Graph data can be stored for 31 days 23h 45m 0s.](#)

- Sensor Control
    - On
    - Off
    - Toggle Off-On
    - Toggle On-Off

---

  - View Graph
  - Enable Graph**
  - Acknowledge
- 
- Settings

If you want to view multiple sensor graphs, first you need to **Enable Graph** for a sensor that supports graphing from the sensor's menu. Then select **View Graph** to display it. The data collection will run in the background even if you don't display the graph.

The second graph will appear below the first graph (you can freely rearrange it).

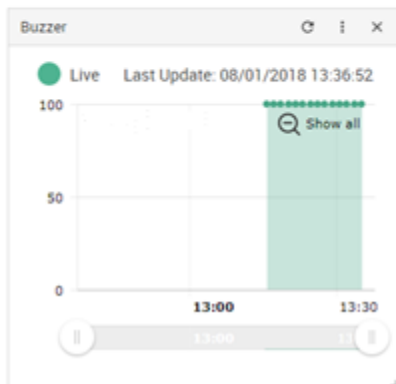
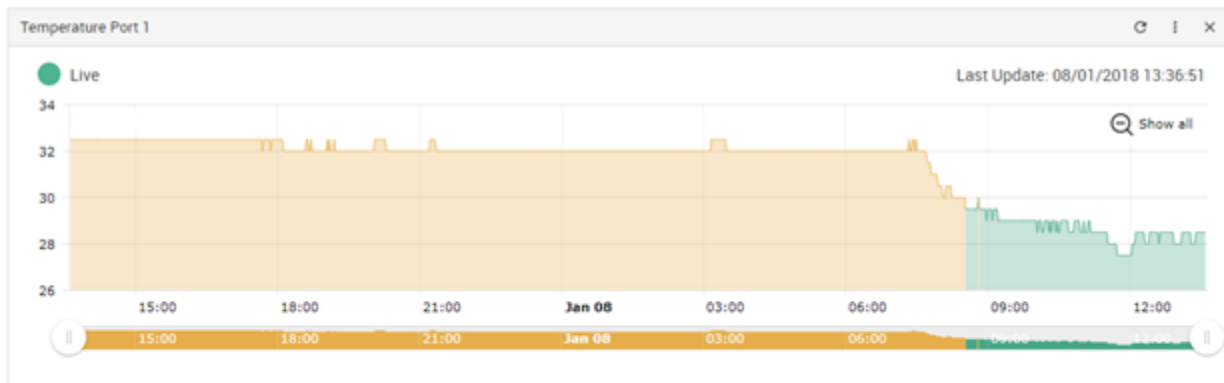

## Expansion Units

If you have an expansion unit connected and sensors on the expansion board, they will be also listed in the System Name Information window as shown below. If you have a BEB unit, please refer to that separate manual titled SPX+ BEB Units. BEB units are NOT supported on the SP2+, only on the SPX+ units. E-sensor8 & E-opto16 expansion units are supported on the SP2+ and SPX+.

System Name (System Location)				Host Log #1
Module 0 - 4x Sensor Ports	Door Port 4		Closed	
Module 0 - 4x Sensor Ports	Reader Port 4		Awaiting Input	19/03/2018 09:51
Module 0 - 4x Sensor Ports	Temperature Port 1	26.5 °C	Normal	19/03/2018 08:41
Module 1 - 20x Dry Contacts IO	Dry Contact Port 1		Critical	19/03/2018 08:41
Virtual Sensors				19/03/2018 08:41
<b>CCU (0D000037)</b>				19/03/2018 08:41
CCU 1.2	Cabinet Door Port 1		Forced Open	19/03/2018 08:41
CCU 1.2	Cabinet Door Port 1 (Reader 2)		Awaiting Input	19/03/2018 08:41
CCU 1.2	Temperature Port 1	26 °C	Normal	19/03/2018 08:41

Temperature Port 1
● Live

In the picture above we have a CCU (Cabinet Control Unit) connected as an expansion board, with an additional Temperature Sensor connected to one of its ports.

The base unit (listed as System Name) can be changed by clicking on the link also has a Temperature Sensor connected to Port 1.

## Managing Desktops and Maps

The updated SP+ Web UI has the Workspaces feature from the AKCPro Server's HTML5 UI. With this you can manage and view different Desktop layouts in a quick and easy way, create multiple custom Desktops as well as select from pre-defined layouts with placeholders for displaying your sensor gauges, logs etc.

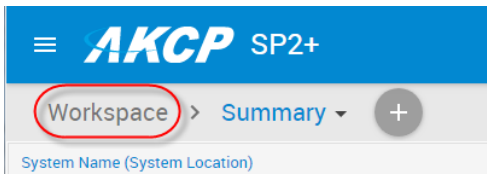

To enter into the Workspace mode, click on the Workspace link circled in red as shown above.

The default Desktop is the Summary page on all devices.

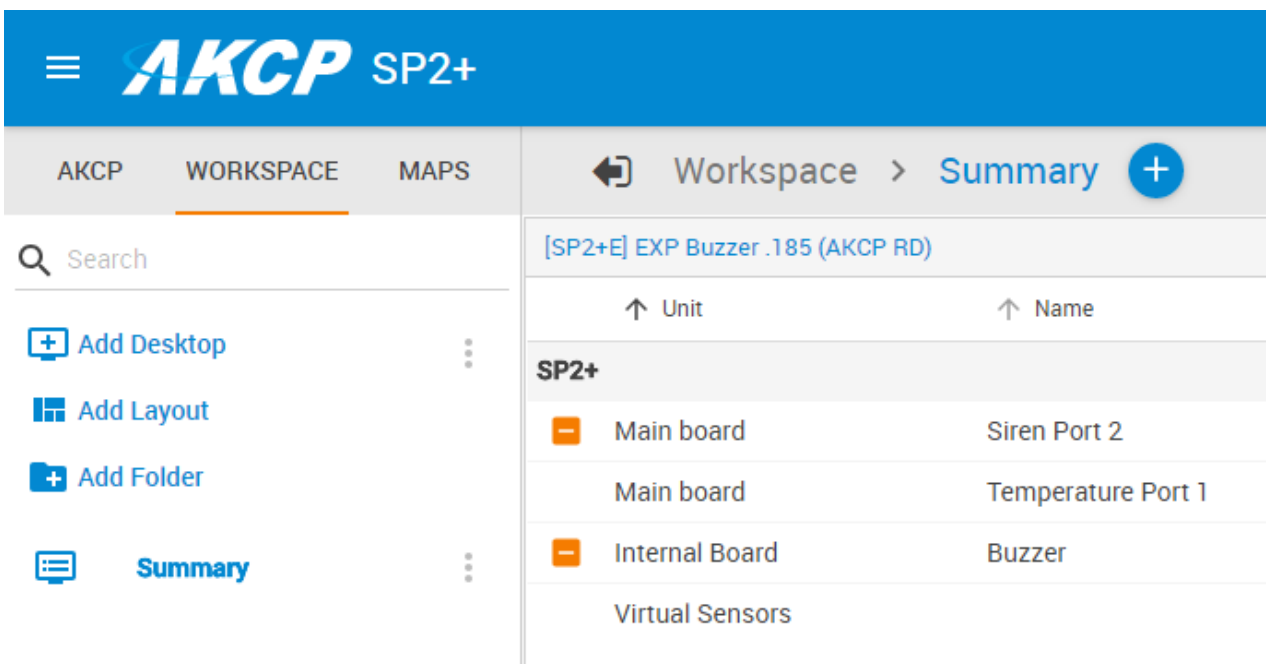

## ***Important Notes on custom desktops***

Please note the custom Desktops that are created **ARE NOT** stored in the SP+ units memory. These are HTML based, so they are stored in the browser cache, or local data on the Chrome & Firefox browsers. In other words, the Workspaces are not portable.

So, if you factory reset the unit or clear the cache on your internet browser the folders and custom desktops will be lost.

Generating a backup file from the Maintenance menu will also contain the custom desktops (added after firmware version 1.0.4209).

Without generating a full backup file, you could to export and then import the desktop configuration before you change browser, change your device or before you clear your browser cache. The configuration files will be saved as JSON files.

You can click the Export / Import command on a Desktop to save/reload it individually:

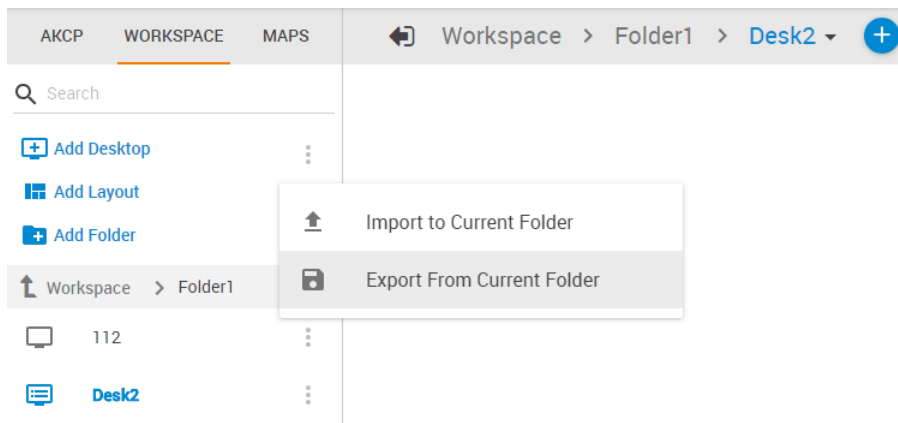

## ***Viewing custom desktops different users & PC's***

Regarding the viewing of your custom desktops via other users. Because multiple users can log into the SP+ unit from the same PC or different PC's on the network, the following applies:-

If two different users (different usernames) log in to the same SP+ unit they will not be able to view the other users custom desktops.

If the same user logs into the SP+ from two different PC's they will not be able to view the custom desktops (they do not synchronize), so the custom desktops will only be viewable on the original PC that they were created on as again these are stored on the PC's browser local data.



## Managing Desktops

### Navigation

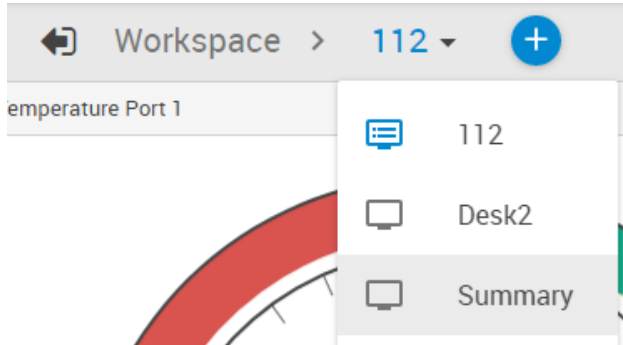

You can manually change between Desktops using the arrow menu, or by directly clicking on the desired Desktop if they are stacked under a folder.

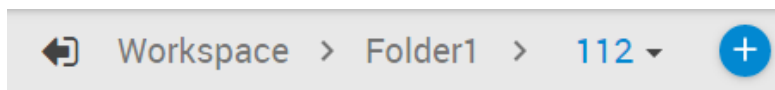

With this button, your current Desktop will expand to the browser's screen width as shown on the screenshot below:

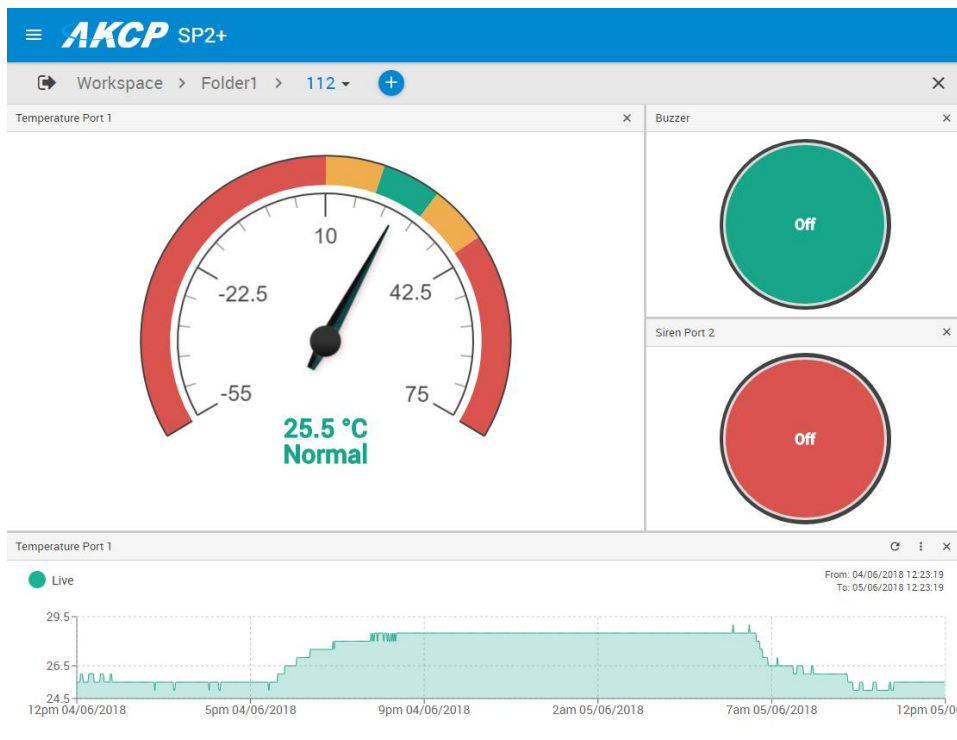

Click it again to go back to the full view.

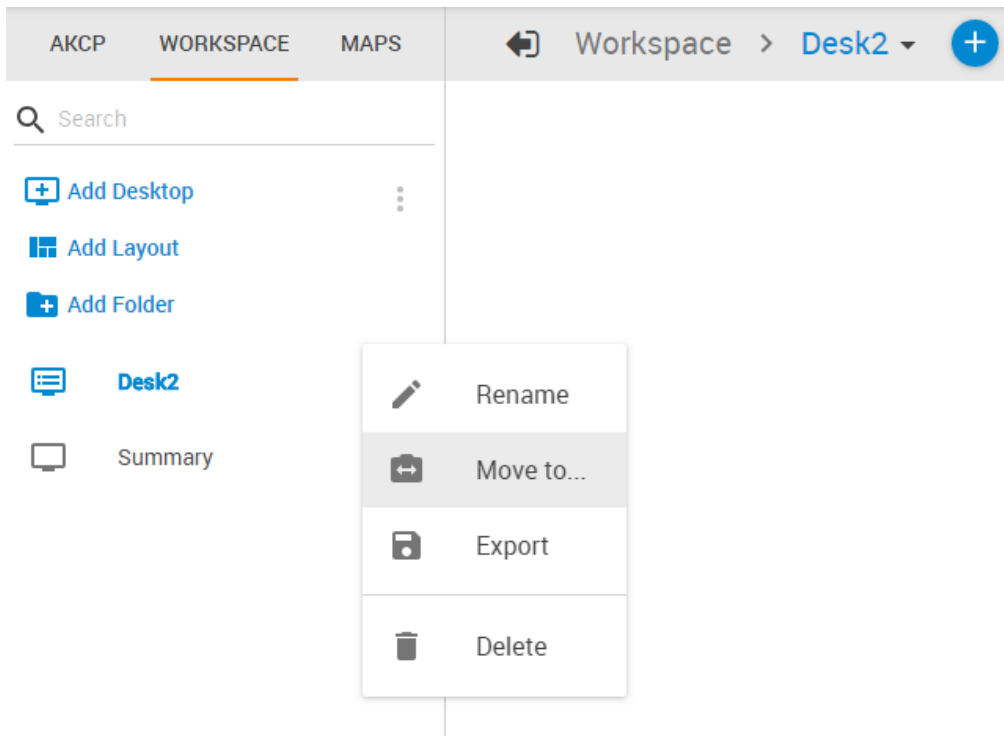

On each Desktop and Folder item, you have the option to Rename, Move, Export or Delete them. Move is useful if you've created multiple folders (see below). As noted earlier, don't forget to export your Workspace items to save them permanently.

## Folders

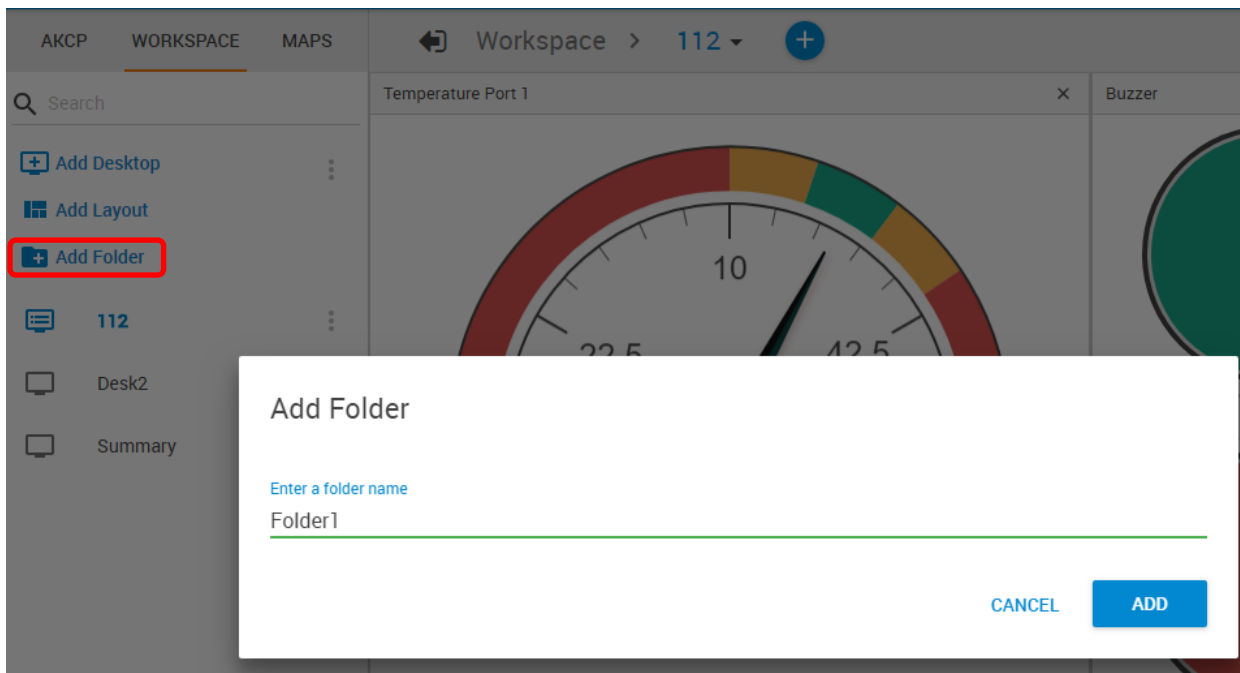

You can add Folders to arrange your desktops into a hierarchical view.

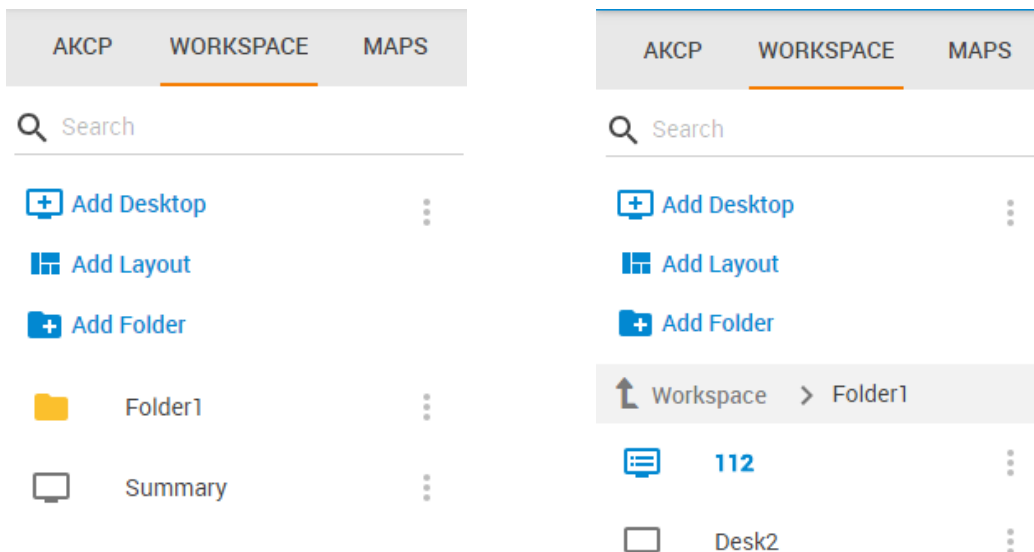

After created, you can simply drag and drop your Desktops under the folder, or use the Move menu. The folder structure will also display on the Desktop selector menu on top:

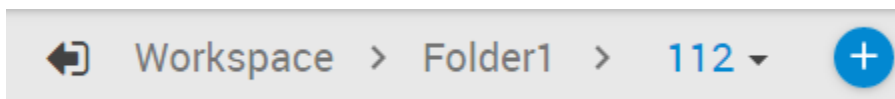

## Desktops

You can add new Desktops where you can customize the layout to place any sensor gadget, logs, graphs etc. on the screen.

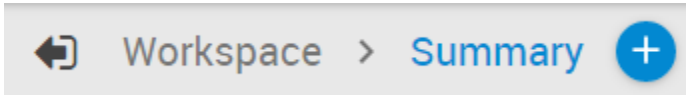

There are two ways to add a new desktop. The first is by creating a blank desktop using the **Add Desktop** link under the Workspace tab:

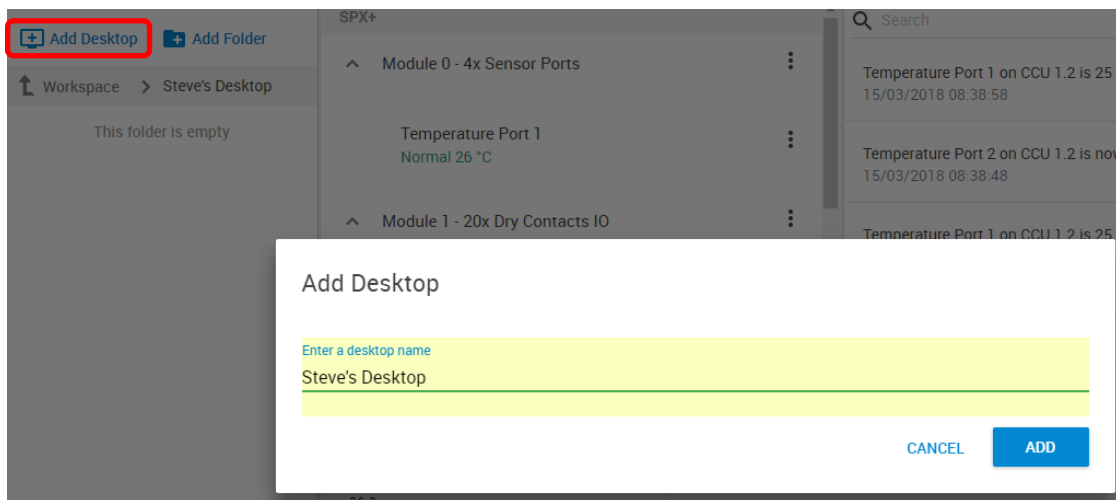

Name the new desktop and click the **Add** button.

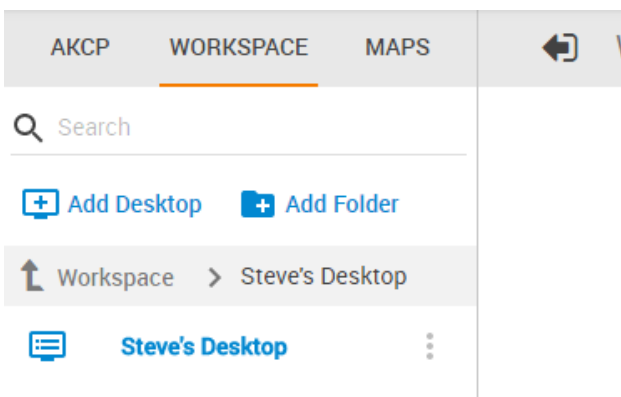

It will appear in the Workspace menu list.

In addition to the simple blank desktop, the second way to add a new desktop is via pre-defined Desktop Layouts. You could choose one that best suits your monitoring needs to drag and drop your sensor gadgets.

Use the plus button at the top of the page and select the layout for your new desktop:

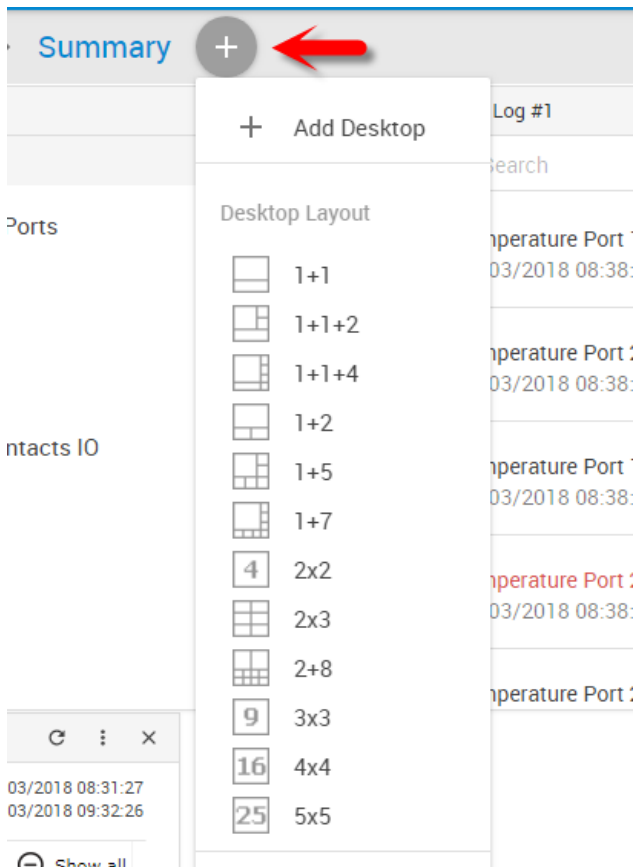

Alternatively you can click on the Add Layout link to select from layouts:

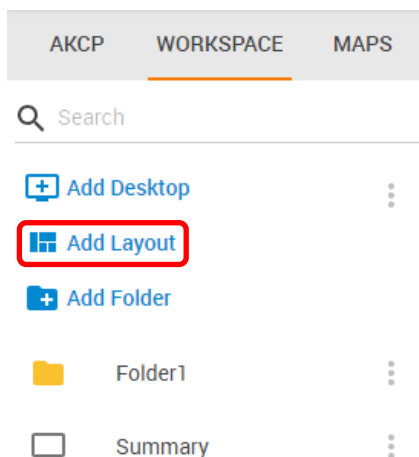

The empty desktop will have placeholders similar to this:

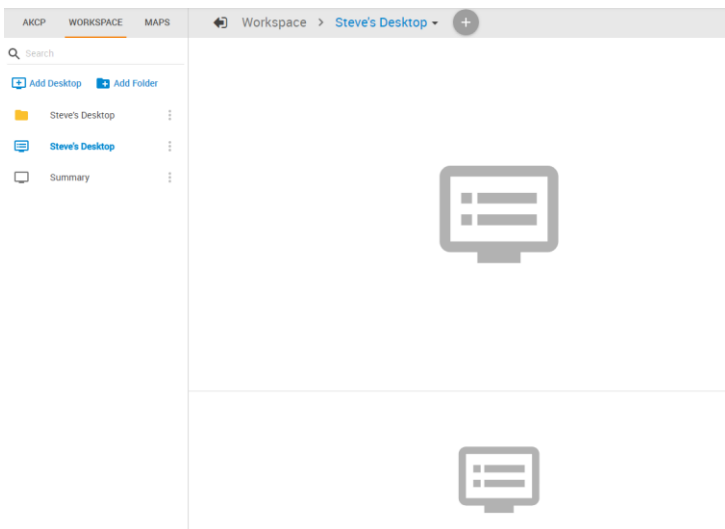

As an example below, we've selected the 1+1+2 layout. Then you can drag and drop sensors, logs and graphs on the layout:

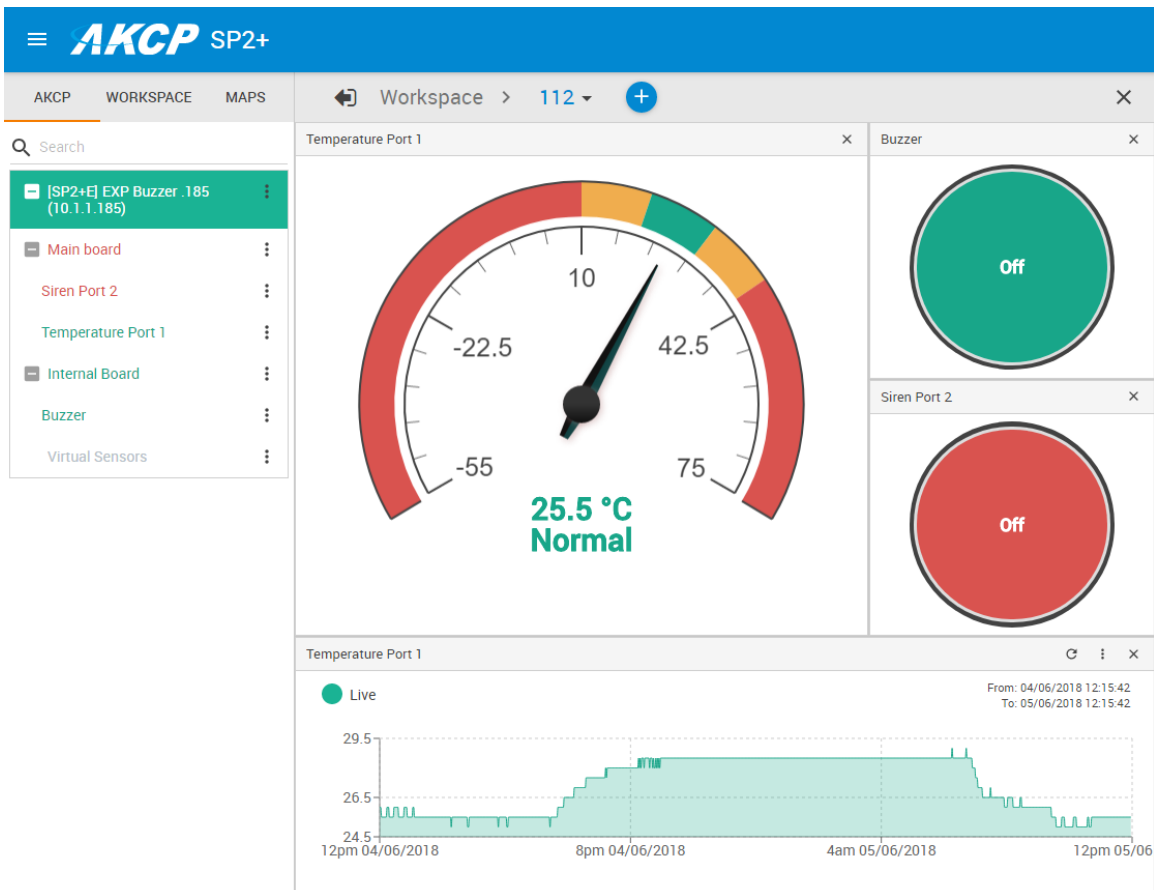

Below we'll show you how you can add sensors to the desktops.

### Adding items to your custom desktop

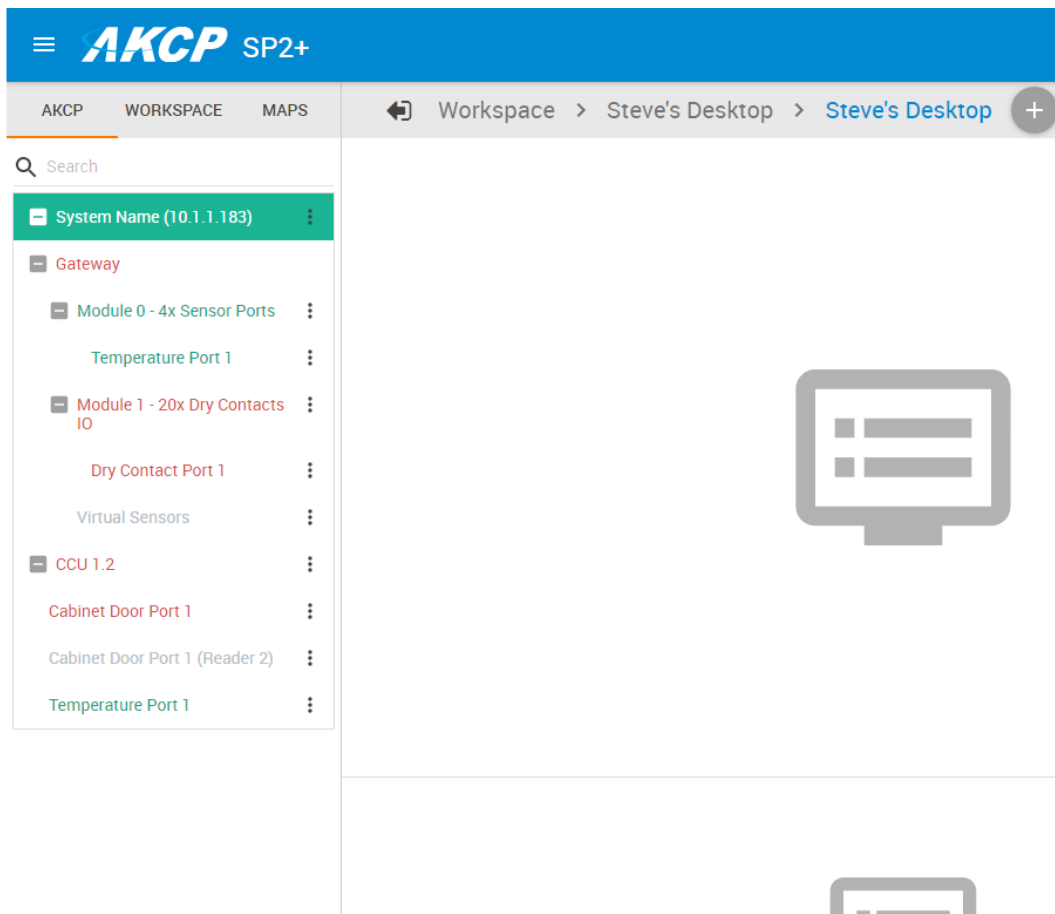

To add items from the units that are connected to the SP+ unit, you will first need to click on the AKCP link in the Navigation Tree as shown above.

Next simply drag and drop the items you wish to add to your new desktop. This is also how you can add items to the Summary page. To navigate back to the Summary or Main Monitoring page click on the Summary link shown below.

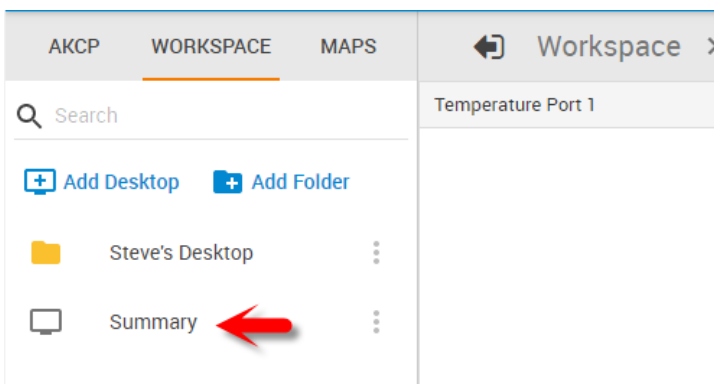

### Desktop Auto Scroll feature

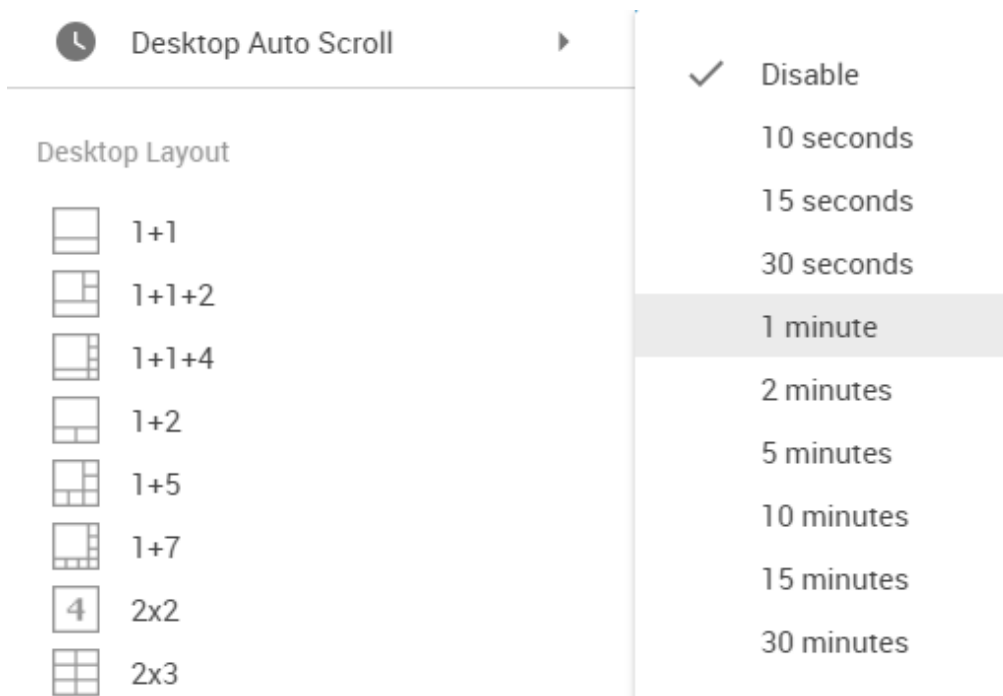

With this feature enabled, your desktop view will automatically switch between the created additional desktops within the specified time interval.

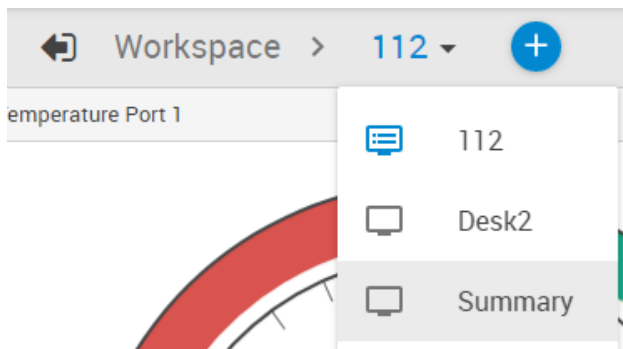

You can also manually change between Desktops using the menu.



## Managing Rack Maps

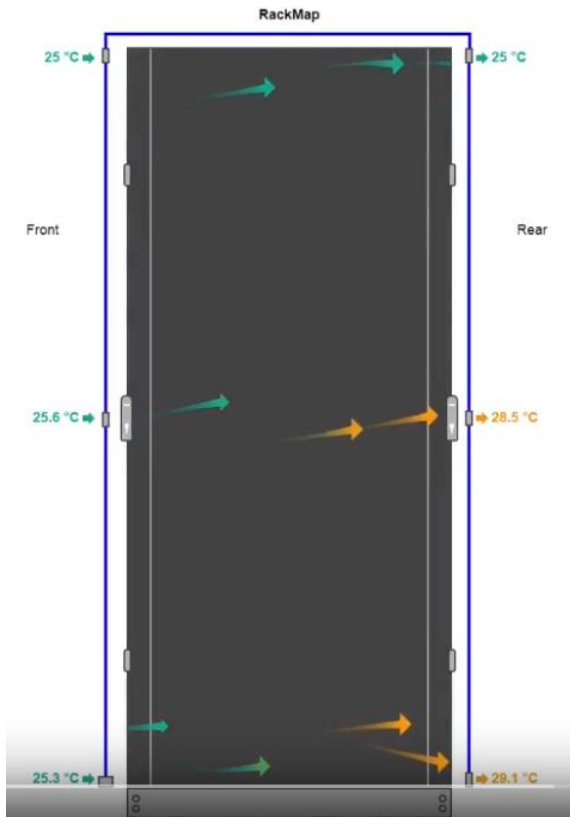

The Rack Map feature was originally (and still is) included in the AKCess Pro Server / AKCPro Server (HTML5) and has also been added to the SP+ units. You can add a Rack Map as a graphical representation of your server rack, and to display and record the temperature of the airflow within your server cabinets.

Note that on SP+ family Web UI only limited options are available for the Rack Map; for example you cannot add devices or assets.

Click on the Maps tab and Add Rack Map link to add a Rack Map:

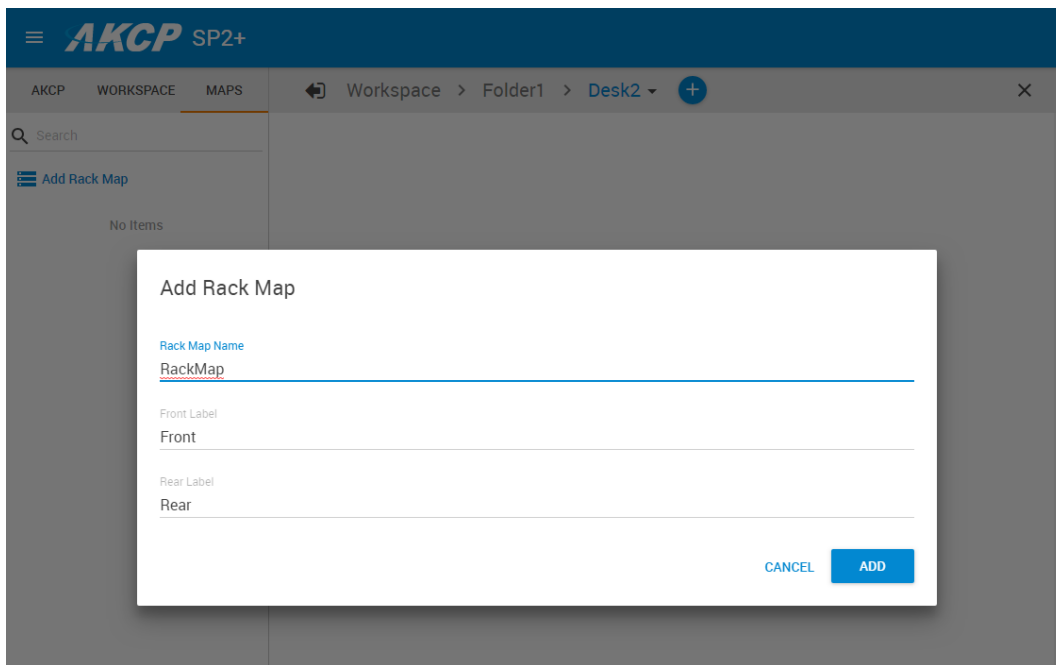
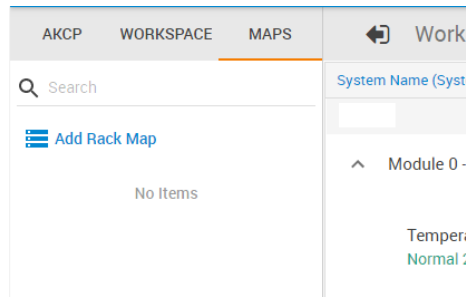

After created, you can drag and drop the Rack Map to a desktop.

You can add Temperature sensors, the Swing Handle Lock and the Sensor Status Light gadget on a Rack Map. Simply drag and drop the desired sensor from your unit's sensor list, as shown below.

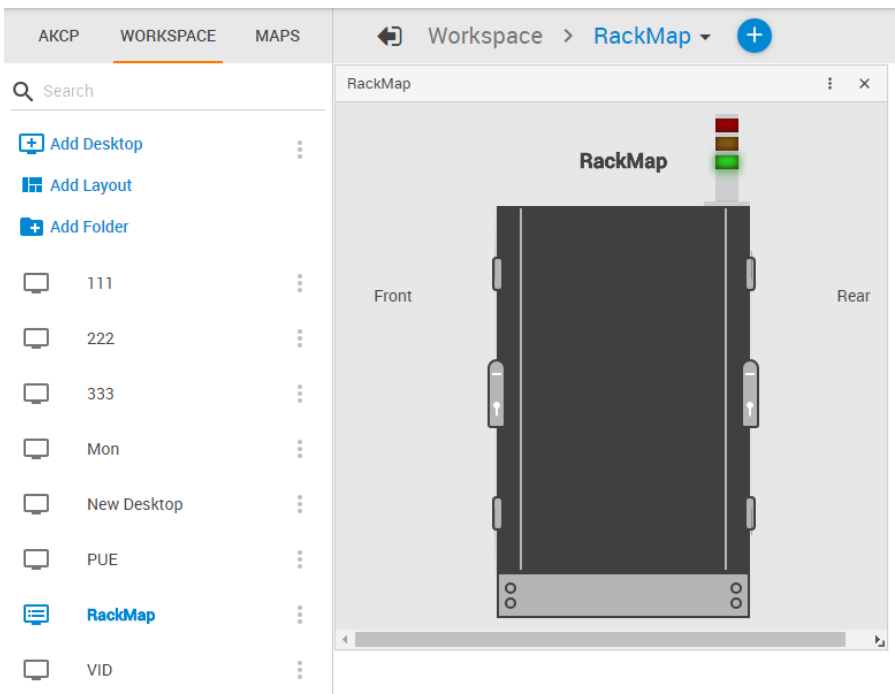
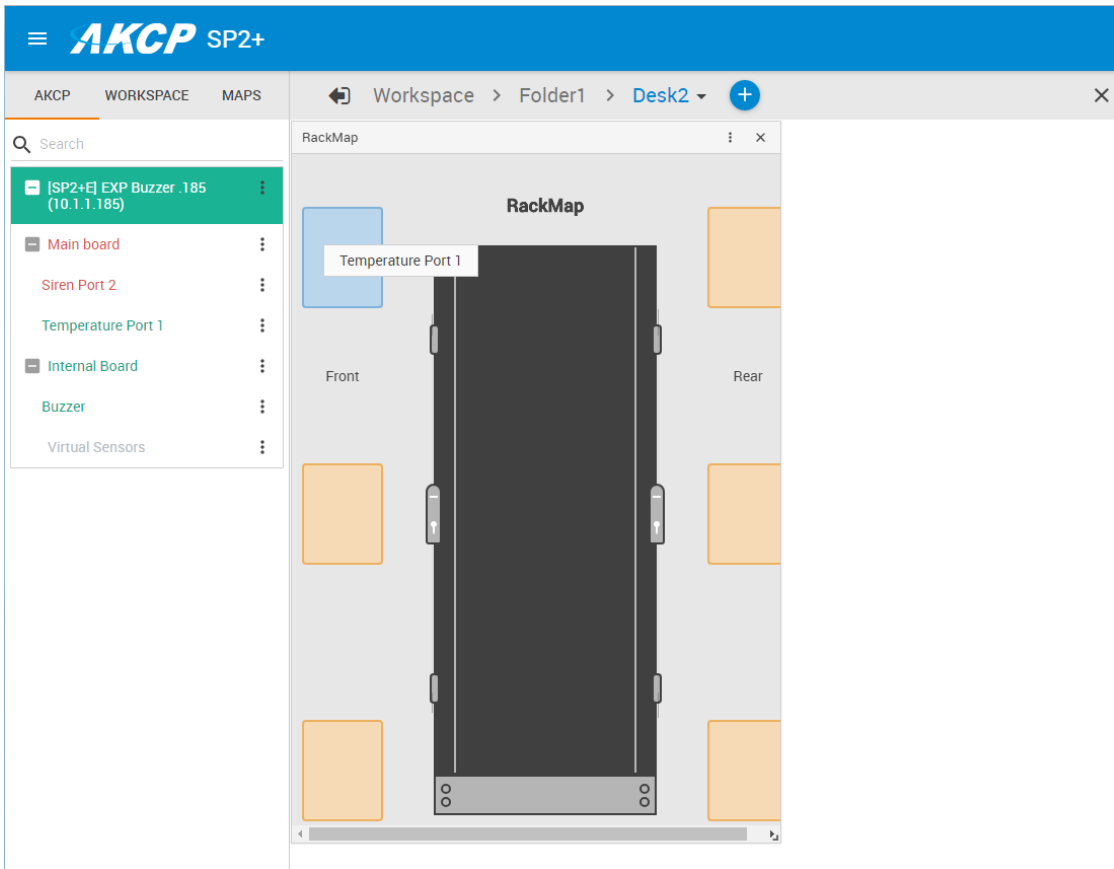

This example picture shows a Sensor Status Light added to a Rack Map.

Please see the Thermal Map sensor manual for complete installation & setup instructions for the Thermal Map sensors.

## Access Control Users and Groups

- Access Control ^
- Users
- Groups
- Time Schedules
- Holiday

The Access Control Users and Groups are managed from the AKCPro Server and are used for accessing doors with the Swing Handle Lock. You can only view the existing users and groups from the unit's Web UI and modify only a few parameters on them.

↑ First Name	↑ Last Name	Group	Card ID	
Admin	Admin	(None)	-	
Jo	Jo	(None)	-	
mot	mot	(None)	-	

This feature has its own manual, refer to the SP+ Swing Handle Lock Manual for more information.

## Notifications and Events

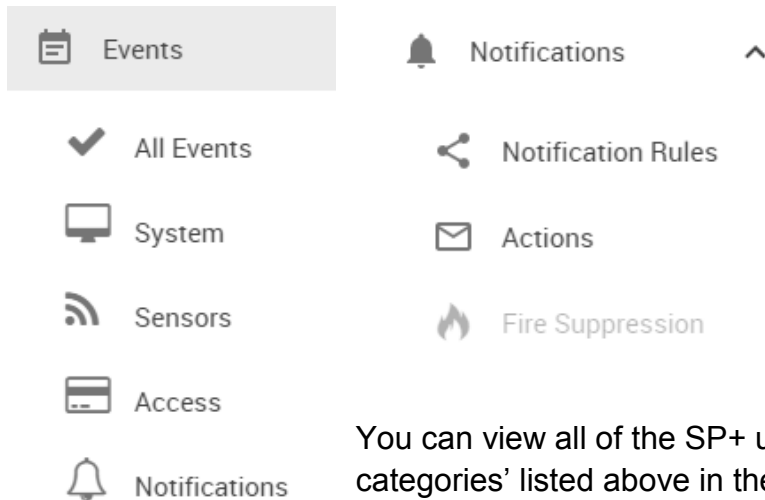

You can view all of the SP+ unit's events and filter them by each of the categories' listed above in the Events drop down menu.

Please refer to the SP+ units "Notifications Manual" for setting up the alerts and the Event log on the units.

## The Sensors menu

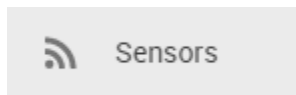

The "Sensors" shortcut will allow you navigate directly to the sensors setting page where you can setup the sensors connected to the unit. This is covered in the Sensors section in this manual.

## The Settings menu

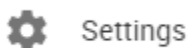

This shortcut will take you to the unit's system settings pages. Each page will be described below in detail.

## System page

### General

Here you can change general settings for the device.

The unit's firmware version is shown in the Description field, and the System Name/Location/Contact options are user configurable. You could also specify the System URL option, for quick access of a custom part of the Web UI for example, but you can specify any URL.

With newer firmware you can also specify GPS coordinates.

By changing the **Graph Data Collection Period**, you can choose how frequently the data is sampled. Note that if you had stored graph data previously, changing this setting will clear the data.

With the option **Sensor Notification On System Boot Up**, you can choose to allow/disallow running the notifications with sensor values read at system boot up. In some cases, invalid values are read while the unit is starting up, and you could get false alarm notifications. You can enable/disable the notification processing at startup with this option.

On each System subpage you can see a **Get SNMP OID** button (where applicable):

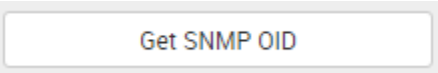

#### SNMP OID of General

Description ▲	Syntax ▼▲	Access ▼▲	SNMP OID ▲
cfgSystemDescription	DISPLAY STRING	read-write	.1.3.6.1.4.1.3854.3.2.1.8.0
cfgSystemName	DISPLAY STRING	read-write	.1.3.6.1.4.1.3854.3.2.1.9.0
cfgSystemLocation	DISPLAY STRING	read-write	.1.3.6.1.4.1.3854.3.2.1.10.0
cfgSystemContact	DISPLAY STRING	read-write	.1.3.6.1.4.1.3854.3.2.1.11.0
cfgGraphDataCollectionPeriod	INTEGER	read-write	.1.3.6.1.4.1.3854.3.2.1.104.0
cfgSystemURL	DISPLAY STRING	read-write	.1.3.6.1.4.1.3854.3.2.1.107.0

This will give you a popup window with all relevant OIDs for the actual page (here the General page is shown).

You can use OIDs for SNMP calls and in custom scripts, or for setting up the unit for monitoring by a third party NMS software such as WhatsUpGold or Paessler.

This button is also accessible on the *Sensors page* for each sensor.

## Language management

Language English Manage

You can change the display language of the Web UI with this option. Only one additional language is supported, together with the default (and fallback if there's an error) English.

**Language**  
System / General / Language

Default Language	English (en) 1.4
Custom Language	N/A
Edit Language	<input type="button" value="Edit"/>
Install New Language	<input type="text" value="Language Packs (Require Internet)"/> <input type="button" value="Install"/>
Download Language File	<input type="text" value="English"/>
Upload Language File	<input type="text"/> <input type="button" value="Choose file"/>

**⚠** The new language file will overwrite the existing file after being uploaded.

In **Manage**, you can choose to **Download Language File** if you'd like to edit the language file offline (you can also download the custom language's file if it's already present). Then upload the completed file, and it will be selectable as the Custom Language. For official translation files, the language code and version will show the correct values.

*Note:* Whenever you upload or install a custom language file, it will overwrite the old file. Only one additional language is supported.

You can get separately downloadable language files from our website in the Support section.

If you have active internet connection, the unit supports installing the official language files directly from our server.

Select a language from the drop-down menu **Install New Language**:

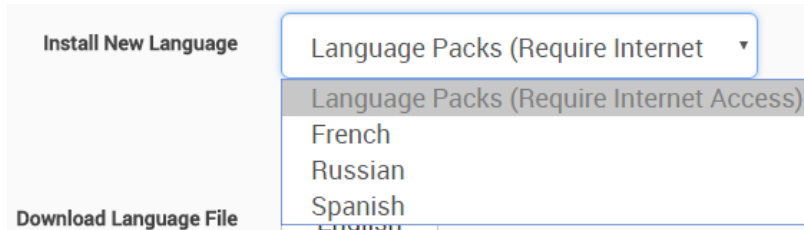

Then press the **Install** button. It will ask you to confirm the action in a popup window:

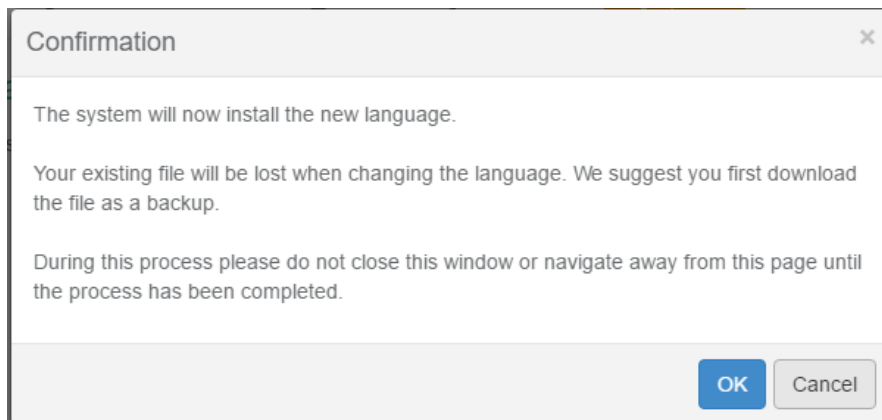

Wait until the language is downloaded and installed:

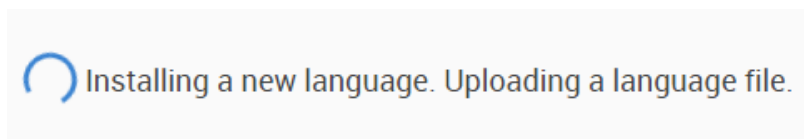



The unit will notify you about the successful language installation. If you installed it from the list, it won't change the language of the Web UI automatically.

Now you can switch display languages by selecting from the drop-down list on the **General** page, then pressing **Save**:

A screenshot of a web interface showing a 'Language' dropdown menu. The menu is open, displaying 'English' and 'Spanish' as options. To the right of the dropdown is a blue 'Manage' button.

After you've added the custom language, you can manage it from the same menu:

A screenshot of the 'Language' management page. The page title is 'Language' and the breadcrumb is 'System / General / Language'. The page contains several sections:

- Default Language:** English (en) 1.4
- Custom Language:** Spanish (es) 1.4
- Edit Language:** A button labeled 'Edit'.
- Install New Language:** A dropdown menu showing 'Language Packs (Require Internet)' and an 'Install' button below it.
- Download Language File:** Two buttons labeled 'English' and 'Custom'.
- Upload Language File:** A file upload area with a 'Choose file' button.

Below the upload area is a warning message: **⚠ The new language file will overwrite the existing file after being uploaded.** At the bottom of the page are two buttons: 'Save' (red) and 'Cancel' (white).

*Note:* The official language files are also included in the firmware update packages.

You can also edit the chosen language directly in the Web UI, if you choose **Edit Language**:

Custom Language

Group	Total Entries	Translated Entries	
General	110	110	<a href="#">Edit</a>
Setup	25	25	<a href="#">Edit</a>
Code Activation	9	9	<a href="#">Edit</a>
Menu	33	33	<a href="#">Edit</a>
Explorer	3	3	<a href="#">Edit</a>
Gadget	97	97	<a href="#">Edit</a>
Login	6	6	<a href="#">Edit</a>
Sensor Setting	519	519	<a href="#">Edit</a>
Event	120	120	<a href="#">Edit</a>
Notification Type	21	21	<a href="#">Edit</a>
Action Selection	2	2	<a href="#">Edit</a>
Sensors Control Action	6	6	<a href="#">Edit</a>
Relay Action	15	15	<a href="#">Edit</a>
Dry Contact Action	15	15	<a href="#">Edit</a>
Siren Action	13	13	<a href="#">Edit</a>
Door Action	16	16	<a href="#">Edit</a>

## Date/Time

The screenshot shows the 'Date/Time' configuration page in the AKCP SP2+ web interface. The sidebar on the left contains various system settings categories. The main panel displays the following configuration options:

- Timezone:** (GMT+07:00) Bangkok, Hanoi, Jakarta
- Date/Time:** 11/01/2018 10:55:56
- Network Time Protocol:** Continuously
- NTP Server 1:** time.windows.com
- NTP Server 2:** 127.0.0.1
- RTC Battery Status:** Good

At the bottom of the configuration area, there are two buttons: a red 'Save' button and a white 'Cancel' button.

The system date and time with time zone is user configurable, with NTP server synchronization. If the unit is connected to APS (AKCPro Server), then it will sync with the APS NTP service. Also displayed is the status of the RTC battery (good/bad).

F7 units will also let you specify secondary NTP, and secured NTP servers.

This close-up shows the 'Network Time Protocol' dropdown menu. The menu is open, displaying the following options:

- Do not use
- One time
- On system start up
- Once a month
- Once a week
- Once a day
- Once a hour
- Continuously (highlighted)

Below the menu, there are two buttons: a red 'Save' button and a white 'Cancel' button.

You can also select the frequency of NTP synchronization with the drop-down menu.

## Network

The screenshot displays the Network configuration interface for the AKCP SP2+ device. The interface includes a sidebar with various system settings and a main configuration area for the Network. The Network configuration area shows the following settings:

- Use DHCP:** Radio buttons for Enable and Disable. The 'Disable' option is selected.
- IP Address:** Text input field containing 10.1.1.185.
- Subnet Mask:** Text input field containing 255.255.255.0.
- Default Gateway:** Text input field containing 10.1.1.2.
- Domain Name Server:** Text input field containing 8.8.8.8.
- Ethernet MAC ID:** Displayed as 00:0B:DC:10:01:85.

At the bottom of the configuration area, there are two buttons: a red 'Save' button and a white 'Cancel' button.

The unit's MAC ID is displayed here, and all user configurable options for IPv4 with fixed IP or DHCP client mode.

F7 units also have IPv6 settings (separately licensed feature), we have a separate manual about this feature.

## Modem

System

AKCP SP2+

System

- General
- Date/Time
- Network
- Modem**
- VPN
- SMTP
- SNMP
- Server Integration
- Services
- Modbus
- Password Checking
- Maintenance
- Heartbeat Messages
- License Management
- About

Get SNMP OID

Connection Method: Never Dial-Out (Use Ethernet Only)

Connection Type:  Always On  On-Demand

Status: Not Connected

IP Address: 0.0.0.0

SIM Status: Bad

Network Mode: No Service

Signal Level: -101 dBm

Connection Mode: Normal

Access Point Name: Access Point Name

Redial Attempt: 0

Idle time before hanging up: 0 0s

Login Name: Login Name

Password: Password

ISP's Domain Name Server: 0.0.0.0

Save Cancel

If the unit is equipped with the internal modem module, then the modem's **Dial-Out configuration** can be set up here for data connections. Contact your service provider for the correct settings.

You can also see on this page the state of the connection, the **Network Mode** and the assigned IP address when connected, if the SIM card is detected properly by the modem (**SIM Status**), and the **Signal Level**.

Connection Mode	Normal
Access Point Name	Normal
Redial Attempt	PAP:Unsecured
	PAP:Secured
	GPRS:Unsecured
	GPRS:Secured
	Ras

You may select a different *Connection Mode* (PAP/GPRS/RAS).  
The most commonly used is *GPRS Unsecured*.

Connection Method	Never Dial-Out (Use Ether
Connection Type	Never Dial-Out (Use Ethernet Only)
	Dial-Out If Ethernet failed
	Use Dial-Out Only

You may change the *Connection Method* as follows:

- *Never Dial Out (Use Ethernet only)*: the unit will never try to use the modem for sending out notifications. If you don't have Ethernet connection, you should change this setting; otherwise you won't get any notifications.
- *Dial-Out if Ethernet failed*: the unit will only use the modem for sending out notifications, if the Ethernet connection fails.
- *Use Dial-Out Only*: the unit will only use the modem to send out the notifications, regardless of the state of the Ethernet connection.

Connection Type	<input checked="" type="radio"/> Always On <input type="radio"/> On-Demand
-----------------	--

Also you may change the *Connection Type*:

- *On-Demand*: the unit will initiate a connection only when it's necessary for sending out the notifications.
- *Always On*: the unit will keep the connection up, even when there is nothing to send.

*Note 1*: There's no auto-detection feature for the internal modem module, the configuration is always shown even if your unit is not equipped with the module.

*Note 2*: Only insert and remove the SIM card when the unit is turned off. Otherwise you can damage the SIM and the modem.

*Note 3*: The PIN code for the SIM card needs to be removed; otherwise the modem can't use it.

## VPN

System / VPN

**This feature has no license. To request a license click here.**

VPN  Enable  Disable

Status Not Connected

IP Address 0.0.0.0

VPN Server Address

VPN Server Port

VPN Password

Confirm VPN Password

VPN Encrypt Method

This feature requires a separate license. You can read more details about the licensing later in this manual.

This feature is used by connecting the SP+ with the APS VPN server. After the license has been activated and the APS VPN server is set up, you'll need to fill out the same options here to be able to use the VPN connection (see below).

VPN Encrypt Method

- None
- Blowfish**
- AES
- Triple DES

*Note 1:* You can also configure these settings from the APS console for the unit.

*Note 2:* If you use the VPN option, the maximum number of sensors that can be used by the unit will be reduced to 36 on F4 units (no limit on F7).

## Set up VPN connection to APS

In the following pages, we'll describe how to set up the VPN connection to APS.

### 1. On APS HTML, Go to **Settings>Server Settings>Virtual Private Network**

The screenshot displays the 'Virtual Private Network' configuration page in the AKCP Pro Server interface. The left sidebar lists various server settings, with 'VPN' selected. The main panel shows the following configuration:

- Enable VPN Server
- Status: VPN Server is running
- Network Settings**
  - Network Address: 192.168.17.0
  - Subnet Mask: 255.255.255.0
  - Listening Port: 1196
- Authentication Settings**
  - Network Encryption: AES
  - Network Password: (empty field)

At the bottom of the form are 'SAVE' and 'CANCEL' buttons.

**Enable the VPN Server** by clicking on the checkbox, and then change the **Network Password** in Authentication Setting. Remember the **Network Encryption Mode** that you have chosen; you'll need to provide the same setting on the SP+. See more details in the APS HTML manual.

You can also make changes to the network settings, but you'll have to use the same port on both sides of the VPN.

*Note:* The VPN virtual network has to be an entirely different subnet from the one you're currently using, otherwise it won't work!

Ex. if you're using 192.168.1.x network subnet on your LAN, use 192.168.11.x (or any other that's different from 192.168.1.x) for the VPN link.



You could also configure the VPN settings using the deprecated APS Windows Client interface:  
**Settings>Server Option>Virtual Private Network**

The screenshot shows a window titled "Server Options" with a tree view on the left containing "Connections", "Virtual Private Network", "NTP options", "Log options", "LDAP options", and "Server Name Service". The "Virtual Private Network" option is selected. The main area contains the following settings:

- Enable VPN Server
- Status : VPN Server is running.
- Network Setting
  - Network Address: 192.168.11.0
  - Subnet Mask: 255.255.255.0
  - Listening port: 1194
- Authentication Setting
  - Network Password: [masked]
  - Confirm Network Password: [masked]
  - Network Encryption: Blowfish

At the bottom right, there are "OK" and "Cancel" buttons.

## 2. On the SP+ Web UI, enable the VPN

First change the VPN Client on the top to "Enabled" and configure the VPN Settings on the form:

- Specify the AKCPro Server's IP or DNS name in VPN Server Address
- Use the VPN Network Password that you have specified on APS
- Set up the the VPN Encrypt Method on the Encryption tab; use the same setting that you have specified on APS.

After clicking the "Save" button, the unit will ask you to reboot.

After the unit has rebooted and shows "Connected", it will show the VPN client's IP Address.

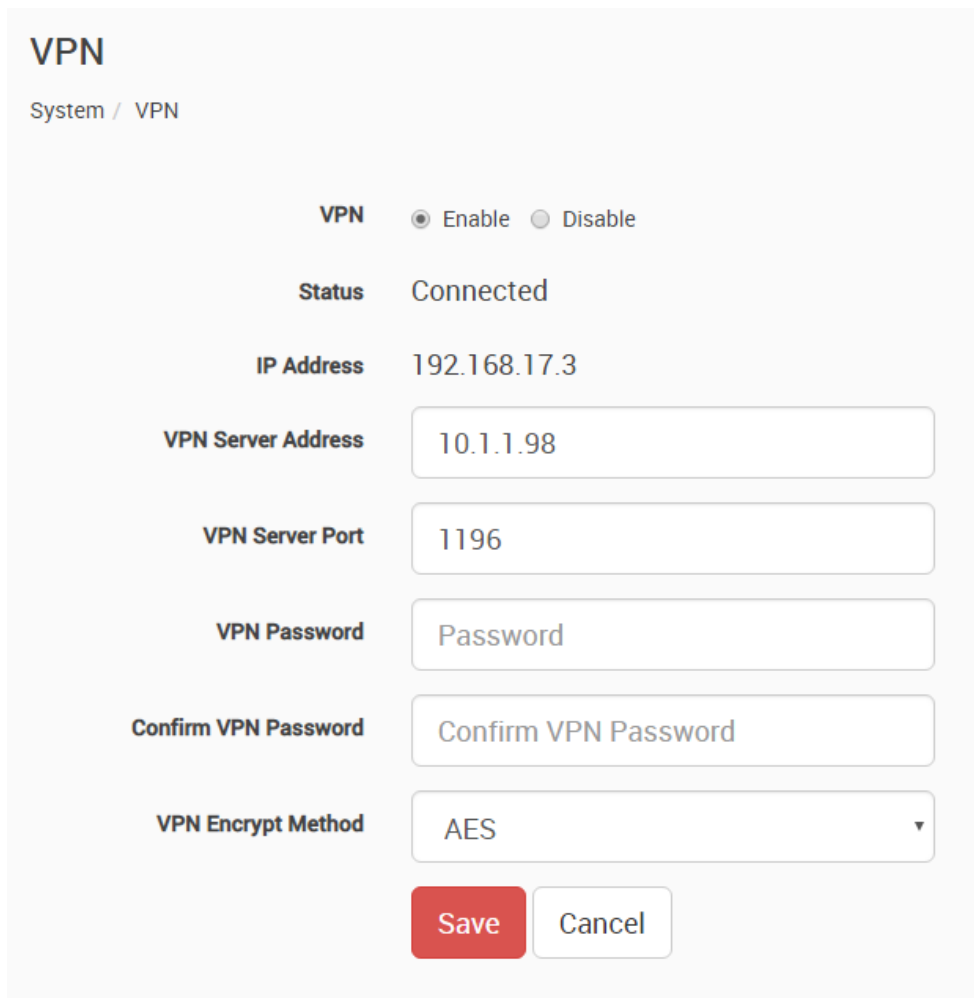

**VPN**

System / VPN

**VPN**  Enable  Disable

**Status** Connected

**IP Address** 192.168.17.3

**VPN Server Address**

**VPN Server Port**

**VPN Password**

**Confirm VPN Password**

**VPN Encrypt Method**

You can review the unit's syslog to see if there were any errors with connecting to the VPN server.

3. On your APS console, the SP+ unit will be added to the **Server Explorer** automatically, with an IP address automatically assigned from the range you specified.

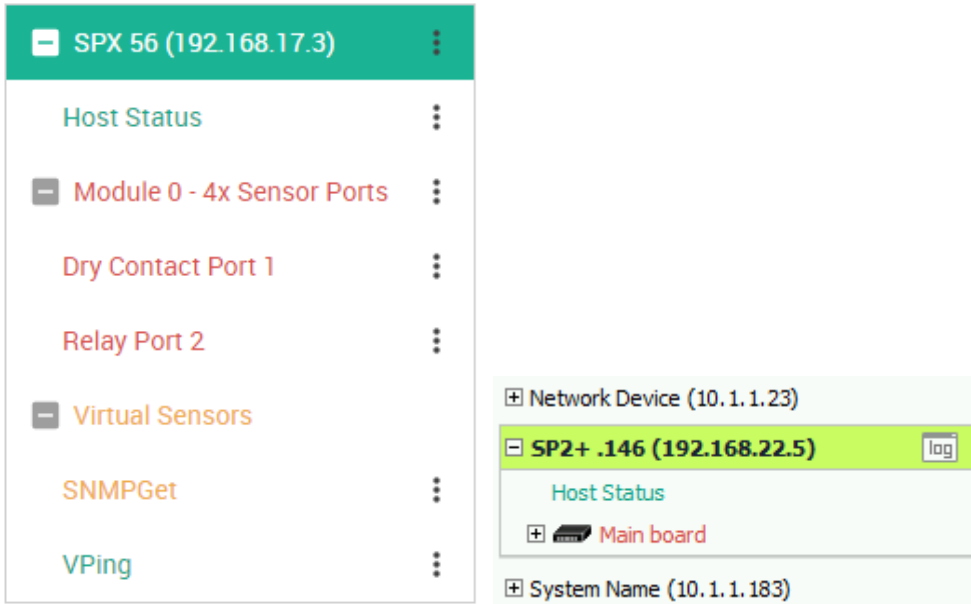

#### Important notes:

- A) If the SP+ was previously added to the APS using a LAN IP, it has to be removed (delete host). Connecting by VPN will use a different IP address for SP+ but the unit's MAC address is the same, and they'll be in conflict. This is not an issue if the unit has never been added to APS before.
- B) If the SP+ unit was previously monitored by APS, you should do a "reset to factory defaults" from the Maintenance menu to fully remove the APS integration from the unit (the existing IP configuration can be kept).
- C) The Virtual Sensor Ping cannot ping an IP address on the VPN network.

#### Important notes for VPN setup with modem connection:

- Port Forwarding to the APS is needed to be set up on your router (allow incoming VPN connection on your selected port)
- The Internal Modem on the unit has to be configured first with the correct APN settings

## SMTP

The SMTP server configuration options are shown here, it's required to be set up for the Email actions.

Fill out all parameters; the address in the *Email From* parameter will be used by the Email actions by default, but you could change it if your mail server supports it (when it's not required to match the SMTP user for example).

SSL/TLS and STARTTLS are supported for the connection security.

You could also turn off any email sending from the unit by disabling the *Send Email* option.

## Settings for Gmail

The screenshot shows the Gmail SMTP configuration interface. It includes a 'Send Email' toggle set to 'Enable'. The 'Email From' field contains a masked email address. The 'SMTP Server' is 'smtp.gmail.com', and the 'SMTP Port' is '587'. Under 'SMTP Authentication', the 'Enable' toggle is selected. The 'Login Name' is the same masked email address, and the 'Password' and 'Confirm Password' fields are masked with dots. The 'Connection Security' dropdown is set to 'STARTTLS'.

You can use Gmail account to send Email alerts with the settings shown on this screenshot on the left.

**Important:** before this can work, you'll need to set up an additional setting in your Google account.

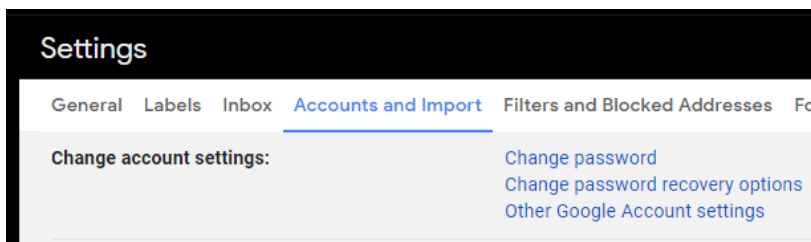

Open Gmail in a web browser and go to Settings / Accounts and Import / Other Google Account settings

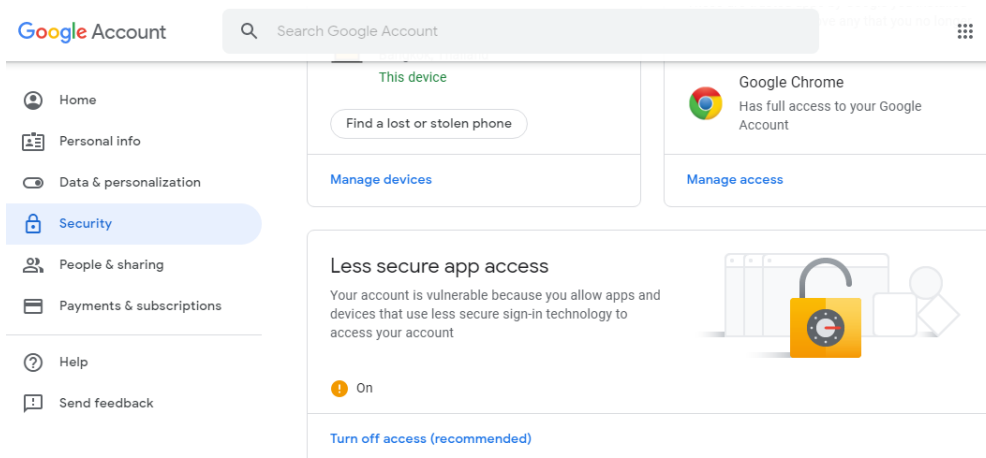

Then from the Account settings open Security tab / **Enable Less Secure Apps**

## SNMP

System / SNMP

SNMPv1/v2c

SNMPv1/v2c  Enable  Disable

SNMP Port

Read Community

Confirm Read Community

Write Community

Confirm Write Community

The SNMP service configuration options are shown here, it is required for SNMP operations.

SNMPv1 is enabled by default, with community password “**public**”.

This is provided for the easiest integration with third party SNMP tools.

For enhanced security, it is recommended that you change the default SNMP password.

Scroll down for SNMPv3 options.

## SNMPv3

SNMPv3

i This feature has no license. To request a license click [here](#).
x

SNMPv3  Enable  Disable

SNMPv3 Mode: Authentication Only

SNMPv3 engineID: AKCP  
engineID parse: 80001F8804414B4350

SNMPv3 Username: admin

Access Privilege: Read Only

Authentication Protocol: SHA

SNMPv3 Pass Phrase: SNMPv3 Pass Phrase

Confirm SNMPv3 Pass Phrase: Confirm SNMPv3 Pass Phrase

Privacy Protocol: AES

Privacy Protocol Pass Phrase: Privacy Protocol Pass Phrase

Confirm Privacy Protocol Pass Phrase: Confirm Privacy Protocol Pass Phras

The SNMPv3 options can be found by scrolling down on the SNMP page.

This feature requires a separate license. You can read more details about the licensing below in this manual.

Below we'll give a quick description of each setting:

<u>Level</u>	<u>Authentication</u>	<u>Encryption</u>	<u>Description</u>
No Authentication	Username	No	Match Username (same as SNMP v1/v2c)
Authentication Only	MD5 or SHA	No	Auth Based on Algorithms (check password)
Auth&Privacy	MD5 or SHA	Yes - DES	Auth Algorithms and Encryption

Basically if you select **No Authentication** then the setup will be the same as with SNMP v1 and v2c versions: authentication is only checked by unencrypted username.

**Authentication Only** will provide password protection but no encryption.

**Authentication&Privacy** provides encrypted username and password protection.

## Server Integration

The screenshot shows the 'Server Integration' configuration page in the AKCP SP2+ web interface. The page is titled 'Server Integration' and is part of the 'System' menu. The configuration options are as follows:

- Server Integration:** Radio buttons for 'Enable' (selected) and 'Disable'.
- Server Address:** 10.1.1.111
- Server Integration Port:** 5000
- Send Keep Alive Every:** 1 Minutes
- Server Access Control Sync:** Radio buttons for 'Enable' (selected) and 'Disable'.

At the bottom of the configuration area, there are 'Save' and 'Cancel' buttons. A 'Get SNMP OID' button is located in the sidebar.

If the unit has been added to the AKCPro Server console, the server's IP address will be displayed here. User configurable options are the APS port and keep-alive period.

The dropdown menu for 'Send Keep Alive Every' is open, showing the following options:

- 1 Minutes
- 30 Seconds
- 1 Minutes (highlighted)
- 5 Minutes
- 10 Minutes
- 15 Minutes
- 30 Minutes
- 1 Hour
- 2 Hours
- 5 Hours
- 12 Hours
- 24 Hours

You can change the APS port when the server's port changes, and the keep-alive period (heartbeat sync to APS).

Alternatively you can re-initialize your unit from the APS console to re-establish communication.

You may disable the **Access Control Sync** on this device. This will disable importing the Access Control users and groups that are set up in APS. This feature is used by the Swing Handle Lock.



## Services

System / Services

Web Interface

Web Interface (HTTP)  Enable  Disable

HTTP Port

Secure Web Interface (HTTPS)  Enable  Disable

Use as Default

HTTPS Port

Upload Certificate File

You can close or change the ports used to access the unit’s web interface, disable HTTP and enable HTTPS only, which can also be set to be used as default.

On the SP+ family, the HTTPS supports TLS v1.1 and v1.2.  
The HTTPS cypher suites are not customizable.

Using the “Upload Certificate File” option you can upload an SSL certificate that will be used by the unit’s Web UI for HTTPS connection (see below).

**Important:** the default, built-in self-signed SSL certificate is only provided for user convenience so that the HTTPS WebUI would work on the units out of the box. It WILL raise browser SSL security warnings and is not meant to be used in production environments where higher security is mandatory. To use SSL without warnings, you need to either add the units IP address to the exceptions, or replace the certificate using the method described below.

## SSL Certificate

SSL certificates are generated for DNS host names and not IP addresses. You should set a host name for the SP+ unit in your local DNS server or DHCP server, and then generate the SSL certificate for that host name.

*Example:* spplus.mycompany.org

The unit's DNS host name is "spplus". Wildcard SSL certificates should also work, but this hasn't been tested.

If the name doesn't match with the one in the certificate, the browser will still show a security warning.

You can purchase a certificate from a trusted, verified Certificate Authority such as GoDaddy or use your company's own CA if you have one.

Please note that only non-password protected certificate files are supported.

When you select the file for uploading, you'll get a warning if the file is not in .PEM format:

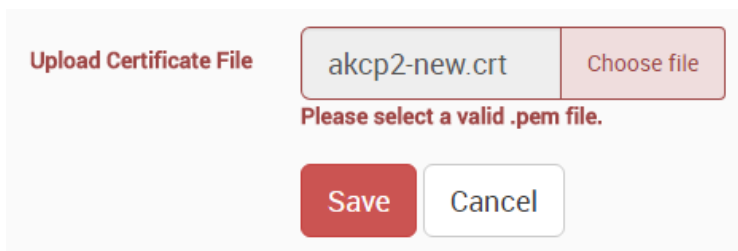

Upload Certificate File

akcp2-new.crt Choose file

Please select a valid .pem file.

Save Cancel



If you don't upload a certificate but enable HTTPS, a built-in certificate will be used. You'll get a browser warning upon opening the Web UI about an incorrect certificate. This is normal and you should add it as an exception or proceed, depending on your browser:

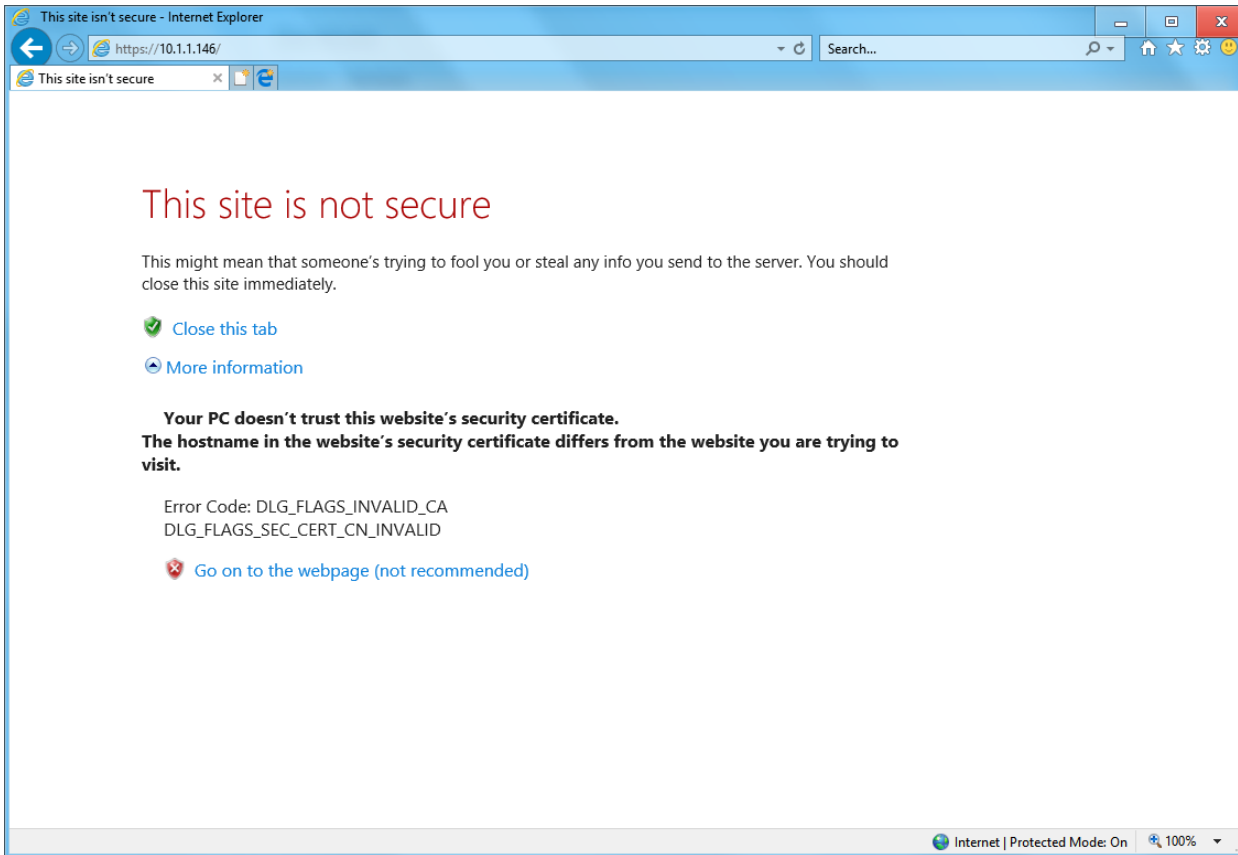

**Important:** the default, built-in self-signed SSL certificate is only provided for user convenience so that the HTTPS WebUI would work on the units out of the box. It WILL raise browser SSL security warnings and is not meant to be used in production environments where higher security is mandatory. To use SSL without warnings, you need to either add the units IP address to the exceptions, or replace the certificate.

## Modbus

MODBUS RTU is a non-proprietary serial communications protocol that is widely used in the process control industry actuation. The sensorProbe+ can represent both “master” and “slave” devices and supports both Modbus RTU (RS-485) and Modbus TCP protocols.

SP2+ Expansion and SPX+ currently only supports Modbus with RJ45 connector (RTU and TCP) on its Expansion port. For just Modbus, only the pin 1 and 2 are used, being respectively, Modbus A/+ and Modbus B/-. You cannot use other sensor ports for Modbus other than the Expansion port.  
*Important: When you use Modbus, you can't connect expansion boards to the unit!*

SP2+ Standard can only use the Modbus Virtual Sensors.

*Note:* Modbus queries are slow (up to 3 seconds). This is per Modbus protocol definition, it's not an AKCP limitation. The more sensors you have, the bigger the polling interval must be.

The screenshot displays the AKCP SP2+ web interface for configuring Modbus. The left sidebar contains a navigation menu with options like System, General, Date/Time, Network, Modem, VPN, SMTP, SNMP, Server Integration, Services, Modbus (highlighted), Password Checking, Maintenance, Heartbeat Messages, License Management, and About.

The main content area is titled "Modbus TCP" and includes the following settings:

- Modbus TCP Slave:** Radio buttons for Enable and Disable (Disable is selected).
- Modbus TCP Unit ID:** Text input field containing the value "1".
- Modbus TCP Data Ordering:** Dropdown menu set to "High Byte First, High Word First".
- Modbus TCP Port:** Text input field containing the value "502".
- Modbus TCP Timeout:** Text input field containing "60000" and a time selector set to "16h 40m 0s".

Below the TCP settings is the "Modbus RS485" section:

- Modbus RS485:** Radio buttons for Enable and Disable (Disable is selected).
- Modbus RS485 Mode:** Dropdown menu set to "Modbus RS485 Master".

At the bottom of the RS485 section are "Save" and "Cancel" buttons.

The "Modbus Sensors Addressing" section contains a table with the following data:

Modbus INPUT Register Address	Unit	Sensor Name	
00000 (0x0000)	Main board	Relay Port 3	
00002 (0x0002)	Main board	Temperature Port 1	

An "Add" button is located at the bottom right of the table.

Configuring the Modbus options and more information about this feature is explained in the separate **SP+ Modbus manual**.

## Password Checking and Security

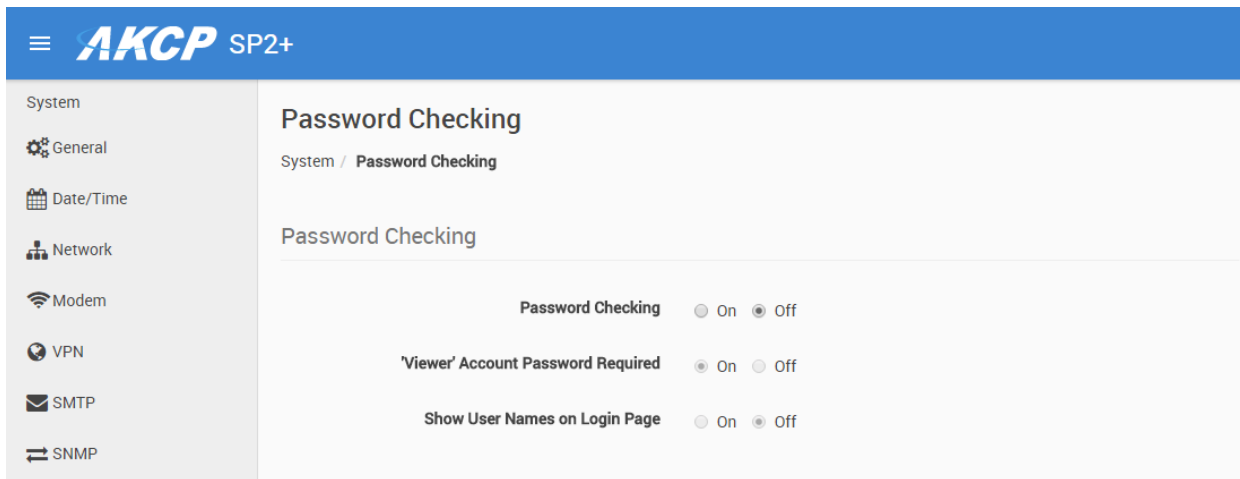

You can turn on the password checking for the Web UI to ensure only authenticated users have access to the unit. You can also specify to show all user names on the login page, or keep them confidential.

After you enable the password checking, you'll need to re-login.

If you don't remember the Admin password, you can hold the unit's reset button for 7-12 seconds to be able to log in to the Web UI without a password.

*Note 1:* The passwords can only be set from the unit's Web UI; this option is not available from APS.

*Note 2:* The default password is "public" for all access levels.

### Web UI user access levels and permissions

**Admin** - full access to all settings, system and notification configurations

**Viewer** - read-only guest access for every page

**User** - full access to most settings except for those which are the system-related such as network

In detail, the User access level provides these permissions in addition to the Viewer level:

- Allow modifying board/sensor settings
- Allow add/modify/remove notifications
- Allow add/modify/remove heartbeats
- Allow open/close the door on the Handle Lock
- Allow send configuration to Support
- Allow change Graph settings
- Allow change the Web UI language



## Password Security options

The screenshot displays the 'Password Security' configuration page in the AKCP SP2+ web interface. The left sidebar contains a menu with 'Password Checking' highlighted. The main content area is titled 'Password Security' and contains two sections: 'Admin Password' and 'User Password'. Each section has input fields for the password and its confirmation, a dropdown for 'Password Expiration' (set to 90 Days), and a dropdown for 'Lock-down period after invalid login attempts' (set to 5 Minutes). A green 'Unlock User Account' button is located at the bottom right of the configuration area.

All user account types (Admin, User, Viewer) have adjustable password expiration and lockdown periods.

The password can be up to 15 characters (a-z, A-Z, 0-9 and special characters).

The IP address of the remote user's computer will be logged in the syslog so you can trace back each login session to its origin.

F7 units also support Radius password checking (licensed separately), we have a separate manual about this feature.

## Lockdown

User Password	<input type="text" value="User Password"/>
Confirm User Password	<input type="text" value="Confirm User Password"/>
Password Expiration	90 Days ▾
Lock-down period after invalid login attempts	5 Minutes ▾
Viewer Password	<div style="border: 1px solid #ccc; padding: 5px;">                 None                  1 Minute                  3 Minutes                  5 Minutes                  10 Minutes                  15 Minutes                  30 Minutes                  60 Minutes                  90 Minutes  <b style="background-color: #007bff; color: white;">Indefinitely</b> </div>
Confirm Viewer Password	
Password Expiration	90 Days ▾

**▲ Error!**  
The username or password is incorrect.

**▲ Error!**  
The username or password is incorrect.

**▲ Error!**  
Your account has been locked because you have reached the maximum number of invalid login attempts. Please try again later.

**▲ Error!**  
Your account has been locked because you have reached the maximum number of invalid login attempts. Please try again later.

Username  
User ▾

•

**LOG IN**

The accounts can be set to lock down the account after 3 invalid login attempts, to prevent brute-force hacking attempts. You can specify how long the account will automatically unlock itself.

Note that for the Admin user, you can't select "indefinitely" as this would prevent you from logging in to the Web UI if it has locked itself.

If an account has been locked, you can unlock it immediately by logging in with the Admin user, and by using the green unlock button:

**Unlock User Account**



## Password Expiration

<b>Admin Password</b>	<input type="text" value="Admin Password"/>
<b>Confirm Admin Password</b>	<input type="text" value="Confirm Admin Password"/>
<b>Password Expiration</b>	<input type="text" value="90 Days"/>
<b>Lock-down period after invalid login attempts</b>	<input type="text" value="None"/>
<b>User Password</b>	<input type="text" value="User Password"/>

You can specify password expiration between every 15 and 90 days for all account types. You could also set “none” to disable expiration.

## Confirmation

Your password has expired. Would you like to change it now?

YES NO

You’ll get a notification upon login when the password has expired, and will be asked to change it. It’s advised to change it when asked, but you can still proceed without changing.

## Maintenance

On this page the following options are available:

*Clear Event Logs:* clears all logged events.

*Restore Original Settings:* removes all customized settings and returns the unit to factory defaults - you can also choose to keep the network configuration intact.

*Backup/Restore All Settings:* the unit's configuration can be backed up to a file and restored quickly and easily. You can choose to keep the present network settings, if the backup file is from another unit. The backup file contains all settings and notifications for the unit.

*Send Configuration To Support:* when asked by Support, this sends the unit's backup file to us. This also contains the device's internal logs which are useful for troubleshooting.



*System Firmware Upgrade:* allows you to upgrade to the latest firmware of the unit - alternatively you could upgrade from APS. We'll show you the process of the Web UI firmware upgrade below in another section.

*System Reboot:* this will initiate a software reboot of the unit, useful when you only have remote access. You'll need to specify the Admin user's password again.

## Heartbeat Messages

The screenshot shows the AKCP SP2+ web interface. The top navigation bar is blue with the AKCP logo and 'SP2+'. A left sidebar contains a menu with items: System, General, Date / Time, Network, Modem, VPN, SMTP, SNMP, Server Integration, Services, Modbus, Password Checking, Maintenance, Heartbeat Messages (highlighted in blue), License Management, and About. The main content area is titled 'Heartbeat Messages' and shows a breadcrumb 'System / Heartbeat Messages'. Below the breadcrumb is a search bar labeled 'Search Heartbeat Tasks' with a magnifying glass icon, a blue '+ Add' button, and a 'Refresh' button with a circular arrow icon. Below these controls is a table with the following headers: Name ^, Task ^, Next Run Time ^, Last Run Time ^, Result ^, and Success ^. The table body is currently empty.

This feature allows you to set up periodical “keep alive” notifications task by email, SMS or SNMP Trap to indicate the unit is still working properly.

We'll show you how to set up these in another manual with the other notifications and actions.

## License Management

System / License Management

[Request License](#) [Refresh](#)

License Type ▲	Total ▲	Used ▼▲	Remaining ▼▲
3rd Party Modbus	3	0	3
5 Dry Contact	3	0	3
Access Control User	100	1	99
SNMPv3	✓	✓	✓
Virtual Sensor	20	2	18
VPN	✓	✓	✓

License Key

Search License Key  [Q](#) [+ Add](#) [Refresh](#)

License Key ▲	5 Dry Contact ▼▲	Access Control User ▼▲	Virtual Sensor ▼▲	SNMPv3 ▼▲	VPN ▼▲	3rd Party Modbus ▼▲	Status ▲
Default License	0	100	5	✗	✗	0	Activated
	3	0	15	✓	✓	3	Activated

Here you can manage the purchased licenses for specific features on the unit.

For example you can request SNMPv3 license by clicking on the **Request License** button. This will send an email to our Sales team with your unit's MAC ID. You can then add the purchased license key with the **Add** button and activate this feature on the unit.

License keys can be backed up/restored with the backup file.  
All keys are unique per device and per feature.

### Features that needs separate licensing:

- **5 Dry Contact option:** Allows you to connect 5 dry contacts (input only) per sensor ports. See below for more information.
- **Access Control User licenses over 100:** The first 100 user licenses are free (1 is always used for the Admin user), and you can get more licensed users in blocks of 100; the limit is 1000.
- **SNMPv3 feature:** Allows you to use and configure secure, authenticated SNMP trap messages.
- **Virtual Sensors:** Allows you to use and configure virtual sensors. The first 5 sensors are free, you can get more license in blocks of 5.
- **VPN feature:** Currently the APS VPN integration is supported, to use a secure VPN channel between the unit and APS. Please note that when using this option, the number of maximum sensors that can be used by the unit will be reduced to 34 on the older F4 units.
- **3<sup>rd</sup> Party Modbus Device:** Allows you to easily integrate your Modbus devices with the SP+ units using configuration template files. This is only available on units with expansion ports.
- **F7 units:** IPv6 and Radius features (see separate manuals about these).

### About Dry Contact Inputs

The dry contact inputs can be configured as **inputs only up to 5 Volts**.

1

Auto Sense

5 Input Dry Contact

2

Auto Sense

N/C

3

Auto Sense

N/C

4

Auto Sense

N/C

5 Input Dry Contact

- Dry Contact Port 1.1
- Dry Contact Port 1.2
- Dry Contact Port 1.3
- Dry Contact Port 1.4
- Dry Contact Port 1.5

5 Input Dry Contact

**Advanced** | Continuous Time

Sensor Name:

Sensor Status: Normal

Sensor Currently: Online

Description of Status When Normal:

Description of Status When Critical:

Description of Status When Sensor Error:

Offline All Sensors In Error On This Port

Save

#### Practical applications:

The dry contact inputs can be used to monitor many types of equipment, for example, you can run the connection from warning lights on alarm panels to the dry contact inputs, so that when the warning light on the alarm panel is activated, the dry contact is triggered, thus allowing you to send notifications via emails or SNMP traps.

## About

The screenshot shows the 'About' page of the AKCP SP2+ web interface. The page has a blue header with the AKCP logo and 'SP2+'. A left sidebar contains a menu with various system settings. The main content area is titled 'About' and shows the following information:

<b>System Description</b>	SP2+ 1.0.4307 May 16 2018 13:56:05
<b>Manufacturing Date</b>	Friday, 24 November 2017
<b>Manufacturer Name</b>	AKCP
<b>Product Name</b>	SP2+ with Expansion
<b>Product Code</b>	-
<b>Ethernet MAC ID</b>	00:0B:DC:10:01:85
<b>Modem IMEI Number</b>	863789020696799
<b>Modem Version</b>	SIM5360E_V3.5

This page shows information about the **Manufacturing Date**, **Ethernet MAC ID**, **System Description** and **unit type (F4/F7)** which are important when you request support. If equipped, the internal modem's details will be also listed here.

You could make a similar screenshot when you need help with your unit, as this information can help us diagnose the problem.

## Sensors page

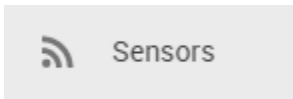

**Module 0 - 4x Sensor Ports**

Sensors / **Module 0 - 4x Sensor Ports**

Port	Label	Status
1	Temperature	Normal
2	Relay	PC power on
3	Thermal Map	Critical
4	Sensor Status Light	Normal

On this page you can view all sensors connected to the unit per port, and per board. Non-connected sensors will be also displayed, until you re-attach or manually remove them from the configuration.

Select an expansion board from the menu list by clicking on it. You can then manage each board and their sensors separately. Below is an example of a CCU board connected to a SPX+ unit:

**CCU 1.2 (0D000037)**

Sensors / **CCU 1.2 (0D000037)**

View **Sensors** Access

Port	Label	Status
1	Siren Strobe	Sensor Error
2	N/C	N/A



Sensors / CCU 1.2 (0D000037)

Board Name

Board Status **Not Connected**

Board Currently

You could modify a connected board by clicking on the pencil icon:

From here you can rename any board, and disable a disconnected expansion board.

The SPX+ units can have extra Dry Contact boards attached. We'll describe more about the Dry Contacts below in another section of this manual; their management is similar to the relay sensor types.

Monitoring

Boards

SPX+

Module 0 - 4x Sensor Ports

Module 1 - 20x Dry Contacts IO

Virtual Sensors

CCU 1.2

Modbus Device

Smart Sensor Recovery

Module 1 - 20x Dry Contacts IO (1E000132)

Sensors / Module 1 - 20x Dry Contacts IO (1E000132)

1	2	3	4	5	6	7	8	9	10
11	12	13	14	15	16	17	18	19	20

Please note the **maximum supported cable length to use with Thermal Map Sensors:**

Maximum extension cable length from the SP+ sensor port to the TMS using CAT5 = 28 Feet

Maximum extension cable length from the SP+ sensor port to the TMS using CAT5e & CAT6 = 60 Feet

**Important note:** If you're using analog pins on the sensor ports (with manually on-lined DCV sensors, and pin 7 of the RJ45 connector) make sure that the **voltage doesn't exceed 3 Volts**. Otherwise you can damage the unit!

## General options for all sensors

You can change the following general options for all sensors:

### Disable Auto Sense

Auto Sense

Click on the **Auto Sense** button to turn off the automatic sensor detection for a port.

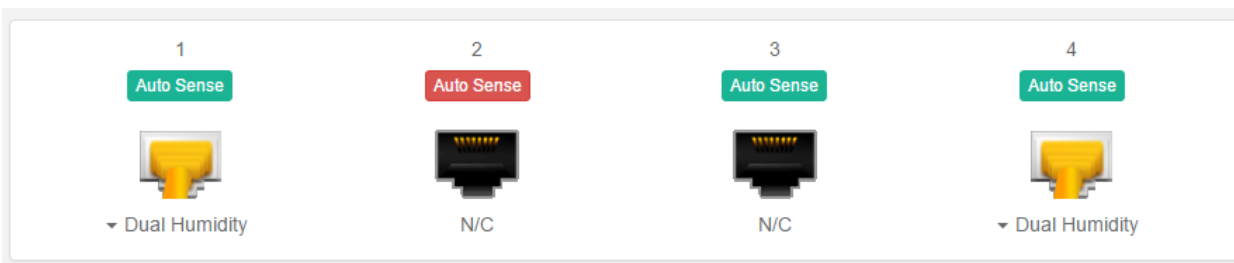

This feature is useful if you want to simulate a sensor (this works for Relay type sensors) or to prevent a sensor from going offline state. Note however that the sensor will be in “sensor error” state if the unit can’t get any reading from the sensor.

### Choose Sensor Type

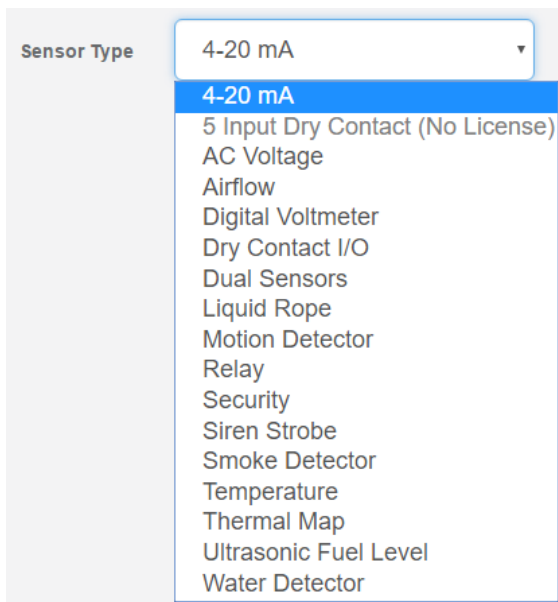

You can pre-configure a specific sensor type if needed, for example if you put the sensor offline before.

## Offline a sensor

Sensor Currently

You can manually offline any sensor by clicking on the green **Online** button on the sensor's configuration page.

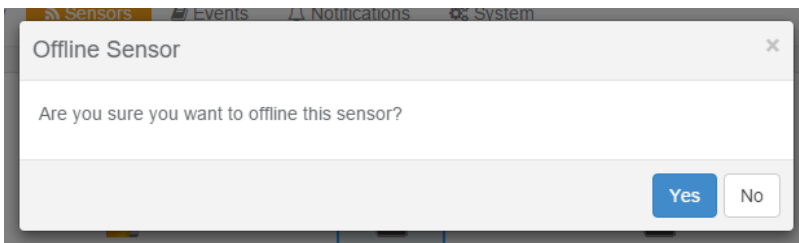

You'll be asked for confirmation in a popup window.

*Note:* if you change a sensor to “offline” it will no longer be displayed on the web interface. In order to reactivate it, you have to toggle it back to “online”.

## Smart Sensor Recovery

This feature will be used **only** for the new **Smart Sensor** type. The firmware can be updated on these sensors automatically, and if the upgrade has failed for some reason and the sensor becomes unresponsive, with this option you can recover them to the default firmware. It's not used by other sensor types.

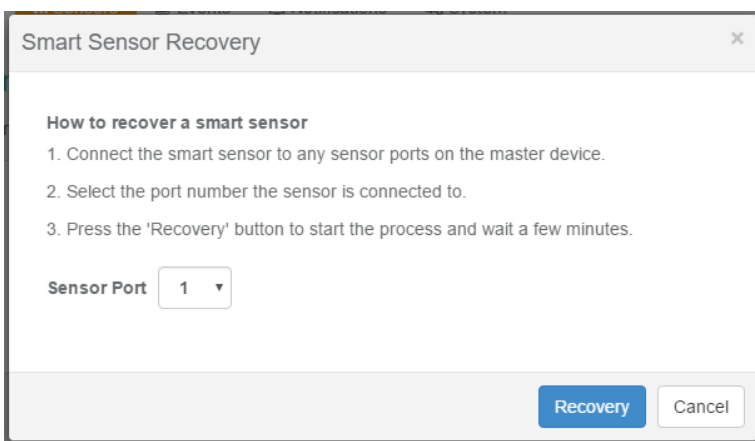

*Note:*

If there's a difference between the version stored in the unit's firmware and the sensor's firmware, it will upgrade/downgrade the sensor's firmware upon powering up/reboot of the unit, or on sensor reconnection.

If you need to downgrade the smart sensor firmware, you can only do so together with the unit's firmware.

## Change Continuous Time

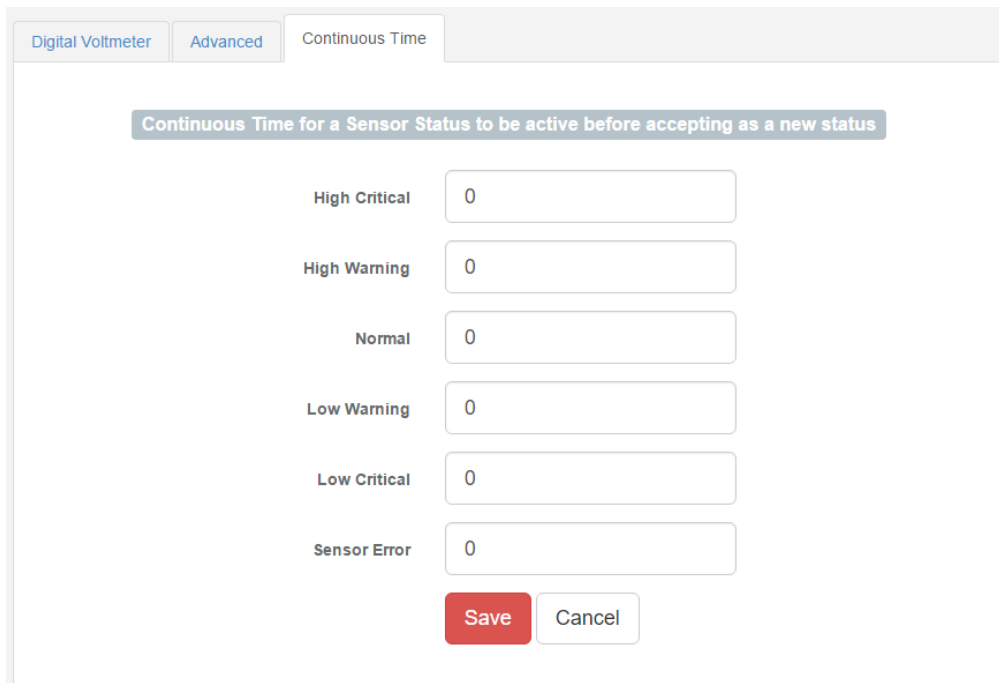

Digital Voltmeter   Advanced   Continuous Time

Continuous Time for a Sensor Status to be active before accepting as a new status

High Critical	<input type="text" value="0"/>
High Warning	<input type="text" value="0"/>
Normal	<input type="text" value="0"/>
Low Warning	<input type="text" value="0"/>
Low Critical	<input type="text" value="0"/>
Sensor Error	<input type="text" value="0"/>

The following advanced functions are for setting the time frame in which the system should delay a notification being triggered when a sensor gives a reading that exceeds the thresholds (high warning, normal, etc).

*Continuous Time to Report High Critical:* This helps to eliminate unnecessary messages during minor fluctuations. You can set the amount of time to delay a notification of a status change from high warning to high critical. Enter the time in seconds and press the “Save” button. The amount of time that can be entered is between 0 and 65535 seconds which equals approximately 18 hours.

*Continuous Time to Report High Warning:* As above but delays notification for “High Warning”.

*Continuous Time to Report for Normal:* As above but delays notification for return to “Normal” state.

*Continuous Time to Report for Low Warning:* As above, but delays notification for “Low Warning” state.

*Continuous Time to Report for Low Critical:* As above but delays notification for “Low Critical” state.

*Continuous Time to Report for Sensor Error:* As above, but delays notification being sent for sensor going into an error state.

*Example:* An airflow sensor or humidity sensor may have temporary drops in readings which are normal operating characteristics; a logical time limit is set to show abnormal conditions.

## Virtual Sensors

**Virtual Sensors**

Sensors / **Virtual Sensors**

1	2	3	4	5	6	7	8
N/C	N/C	N/C	N/C	N/C	N/C	N/C	N/C
9	10	11	12	13	14	15	16
N/C	N/C	N/C	N/C	N/C	N/C	N/C	N/C
17	18	19	20	21	22	23	24
N/C	N/C	N/C	N/C	N/C	N/C	N/C	N/C
25	26	27	28	29	30	31	32
N/C	N/C	N/C	N/C	N/C	N/C	N/C	N/C
33	34	35	36	37	38	39	40
N/C	N/C	N/C	N/C	N/C	N/C	N/C	N/C

On this page you can configure the Virtual Sensors. The first 5 sensors are free; if you need to use more you can purchase additional licenses (see the Licensing section in this manual).

**Sensor Type** Boolean

**Sensor Name**

- Boolean
- SNMP Get
- Virtual Ping
- Logic
- SNMP Trap Receiver
- Modbus

Virtual Sensors can be a very powerful tool in your monitoring system. On the SP+ products you can have up to 32 of these virtual sensors and they allow for a multitude of applications.

SNMP Get, sensor logic evaluation and ping commands among others are all possible from the virtual sensors. An example use of this could be to use the SPX+ as a probe manager. If you had a SPX+ and multiple sensorProbe devices they could all be monitored, mapped and alerted via the SPX+. You can perform SNMP Get commands on a server to monitor memory or CPU load, or you can ping network enabled devices and be alerted if they go offline.

*Please note:*

The Virtual Sensor Ping cannot ping an IP address on the VPN network.

We'll explain more about the Virtual Sensors and how to configure them in the **Notifications manual**.

## Dry Contact Sensors

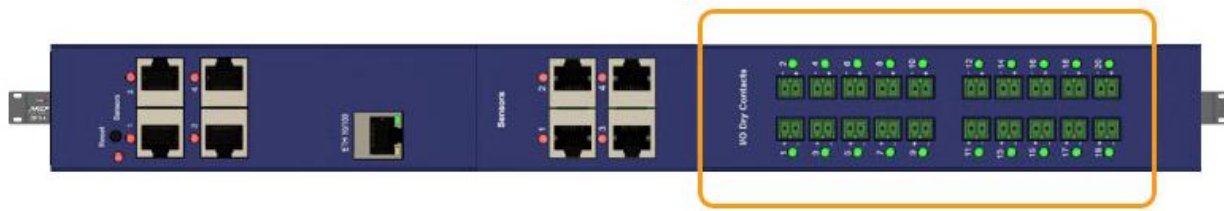

With the user definable Dry Contact Sensor you can monitor a variety of devices and alarm panels with Dry Contact inputs, such as UPS status, security systems, air conditioning status, burglar alarms, fire alarms or any application that requires monitoring by the sensorProbe+.

Depending on your configuration, the Dry Contact Sensors are available in **5VDC input**, **I/O** and **Isolated** configurations. LED indicators show the status of each individual Dry Contact.

These general purpose switches can be either input or output. When used as an output it can source up to 20 mAs. You can select the output voltage by setting the Output Level to a Low or a High. When set to Low, the pin will output 0 volts. When set as a High, the pin will output 5 volts.

When used as an input a switch will retain any error condition until it is read via SNMP. Therefore, if a switch encounters a critical condition at any time, it must report that condition before it can return to a normal state.

Input pins can be used to detect whether or not an input switch is open or closed. In combination with external sensors, input pins can detect whether a door or window is open or closed, if there is a water incursion and many other conditions.

The input pins work by sensing the presence of a voltage level on an input pin. When the switch is open, the voltage is different than when the switch is closed.

To test a Dry Contact input, wire ground to one side of the switch. Wire the other side of the switch to the switch sensor. Set the Normal State field to Open. Set the Direction field to Input. When the switch closes, the input pin will be shorted to ground and the switch will change state from normal to critical.

### **Specifications & Features:**

- Measurement Indication - Alarm or Normal
- Sensor type - open/closed contact switch
- The sensorProbe+ auto detects the presence of the Voltage Sensor
- Measurement rate - multiple readings every second

## Connecting to the Dry Contacts

The SPX+ units are shipped with the green “phoenix” type two pin + & - terminal blocks as shown in the image below.

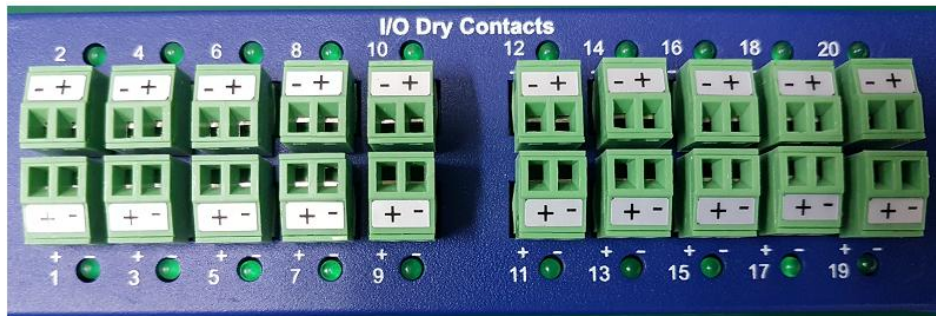

It is very important to take note and correctly connect the polarity of the connections as you can see in the image above as the two rows have a different orientation.

The polarity and the number on the dry contacts are easy to miss when you need to unplug the terminal blocks from the bottom row in order to attach the wires and tighten the two screws that hold them in place. So, we are also adding individual numbers to the terminal blocks as well.

If you do have an older unit that still only has the + - phoenix terminal blocks, please contact us and we can ship you the revised versions.

## Configuring the Dry Contact Sensor

Since all of AKCP’s intelligent sensors are configured similarly, not every field is described below. The descriptions below describe the fields which are special to the Dry Contact sensor. The rest of the configuration is similar to the Relay Sensor (see below in this manual).

**Direction:** The Switch Direction can be either **Input** or **Output**. When set as an Input, the sensor will report its status as either **Normal** or **Critical**. The status is Normal if the Normal State field matches the current value applied to the sensor.

For example, if the Normal State field is High and the input to the sensor is high then the status is Normal. The input voltage should be limited to 0 to 5 volts in order to protect the sensor.

If the Direction of the sensor is Output, the sensor can be used to drive external equipment.



**Description of Status When Normal:** This field is the custom description, which will be displayed in the Status field when the dry contact sensor is Normal.

Examples for this field are: Door Open, Pump Turned On, Light Turned On, etc.

**Description of Status When Critical:** This field is the custom description, which will be displayed in the Status field when the dry contact sensor is Critical.

Examples for this field are: Door Closed, Pump Turned Off, Light Turned Off, etc.

**Output Level:** The Switch Output Level field can be either **High/+5 Volts** or **Low/GND**. When set to a High, the output value of 5 volts will be applied to the switch. When set to a Low, the Output Level field will depend upon the value of Direction. If Direction is set to Output and the Output Level field is set to low, the Switch will source current in order to maintain 0 Volts. If Direction is set to Input and the Output Level field is set to low, the Switch will become tri-state.

The Output level of High will pull-up the switch even if the Direction is set to Input. However, when the Switch Direction is set to Input and Output level is set to high the Switch will output a weak pull-up current. This output can be overridden by shorting the pin to ground. In this way, an external switch can be determined to be open or closed.

**Normal State:** The Switch Normal State field can be either **Open/+5 Volts** or **Closed/GND**. When set to a +5 Volts, the input value of 5 volts will cause the Status to be reported as normal. When set to +5 Volts, the input value of 0 volts will cause the Status to be reported as Critical Low. When the Switch Normal State is set to a Low, the input value of 5 volts will cause the Status to be reported as Critical High, and the input value of 0 volts will cause the Status to be reported as normal.

We'll explain the notification action options of the Dry Contacts in the Notifications manual.

**Information on Dry Contact cables:** The extension length of the Dry Contact twisted pairs is limited only by the amount of electromagnetic noise in the area. So the lengths can be quite long, but long cable lengths may create occasional false positives. These false positives can be eliminated with the advanced filtering of the Dry Contact sensor on the system. You can define how long a sensor must be in the error condition before changing state from Normal to Critical. You can also define how long the sensor must remain in the Normal state before changing from Critical to Normal.

### Isolated Dry Contact details

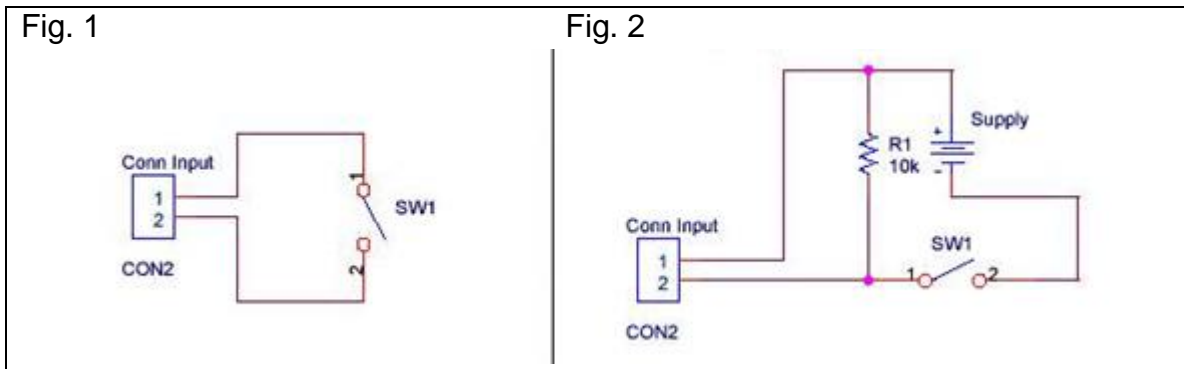

The standard Dry Contacts are as in Fig. 1: directly connected to the unit's controller board. In this setup, power is provided by the sensorProbe+ to the switches. With the sensorProbe+ providing the power, the switch has +5 Volts applied to pin 1 and GND applied to pin 2. When the switch is open, the input senses +5. When the switch closes, the input senses GND. No additional external power is needed.

Fig. 2 shows the optional opto-isolated Dry Contact mode. This provides complete electrical separation between the sensorProbe+ and the dry contact. The sensorProbe+ is therefore protected against possible large voltage spikes caused by lightning for example.

Note that the maximum voltage that can be applied to the dry contact inputs in opto-isolated mode is 30V DC. This will protect these inputs and the unit from high voltages and spikes.

### ***Dry Contact module types***

The optional 10 or 20 dry contact modules for the SPX+ units can be one of three types as follows:-

1. The I/O (input / output) 5VDC
2. The 5VDC opto coupled (non-isolated) input only - make sure you don't exceed 5V or you can damage the unit!
3. The 5VDC to 20VDC isolated input only (no voltage on inputs)

If you didn't specify the type when ordering then the default would be #1, the I/O type.

The I/O dry contacts and the 5VDC opto coupled (#1 and #2) have 5VDC so those outputs (on #1 only, #2 no outputs) will be only 0 or 5V (not open or closed). You cannot set the output on #1 to open or closed because voltage is present on the ports and they are only 0 or 5VDC output.

The option #3 above has the internal fully isolated dry10 or dry20 module option, which will work just like the jumper-selected opto isolated X20 and X60 dry contacts on the securityProbe 5ES-X20 units and can support 24VDC inputs.

The 5 to 20VDC isolated inputs can be setup as Open or Closed (again as inputs only).

There is no voltage present on this type.

The type of the Dry10 and Dry20 modules are silk screened on the modules as shown here:-



## Example sensor configuration

Below we'll show the configuration of 2 sensor types: the Temperature/Humidity and a Relay sensor. The configuration of these 2 types of sensors covers most settings that can be configured for other sensor types.

### Temperature/Humidity Sensor

Click on the sensor port where the sensor is connected to open the sensor's configuration.

*Note:* another way of accessing this page is to click on the sensor from the Summary page.

The screenshot displays a configuration interface for four sensor ports:

- Port 1: Dual Temperature (Auto Sense, highlighted with a blue border)
- Port 2: Relay (Auto Sense)
- Port 3: N/C (Auto Sense)
- Port 4: Dual Humidity (Auto Sense)

The configuration details for 'Dual Temperature Port 1' are shown below:

- Sensor Name:** Dual Temperature Port 1
- Sensor Status:** Normal
- Sensor Reading:** 26.0 °C
- Sensor Currently:** Online

Threshold settings are displayed as follows:

Low Critical	Low Warning	Normal	High Warning	High Critical	
-55	10	20	30	40	75

Buttons for 'Save' and 'Cancel' are located at the bottom of the configuration panel.

From this page you can carry out various operations. You can view the current status (normal, low critical, high critical etc), rename the sensor, put it offline and change the thresholds. In the screen shot above you can see the sensor is indicating a temperature of 26 degrees °C, and a status of Normal.

You can re-configure the thresholds for each sensor state. After changing a threshold value, click **“Save”**. In the next screen shot you can see that a threshold has been changed to 27 make a new “low warning” state, and along with it the sensor status has changed:

Dual Temperature    **Advanced**    Continuous Time

Sensor Name: Dual Temperature Port 1

Sensor Status: **Low Warning**

Sensor Reading: 25.5 °C

Sensor Currently: **Online**

Low Critical: -55 → 10 → 27 → 30 → 40 → 75

High Critical: 75

**Save**    Cancel

Note: the Humidity sensor has the same configuration options as the Temperature sensor.

You might see a **Temperature Search** option for the connected Temperature sensors:

**Temperature Search**    **Search**

Temperature    **Advanced**    Continuous Time

Sensor Name: Temperature Port 1

Sensor Status: **Normal**

Sensor Reading: 27.5 °C

Sensor Currently: **Online**

Temperature Search: **Search**

Low Critical: -55 → 10 → 20 → 30 → 40 → 75

High Critical: 75

**Save**    Cancel

What this button does is to search for new temperature sensors in a chain, if you've connected more than 1 sensor in a Daisy-Chain Temperature (DCT) sensor chain. It is **not** available for Thermal Map Sensors (TMS).

## Advanced sensor configuration for Temperature/Humidity sensors

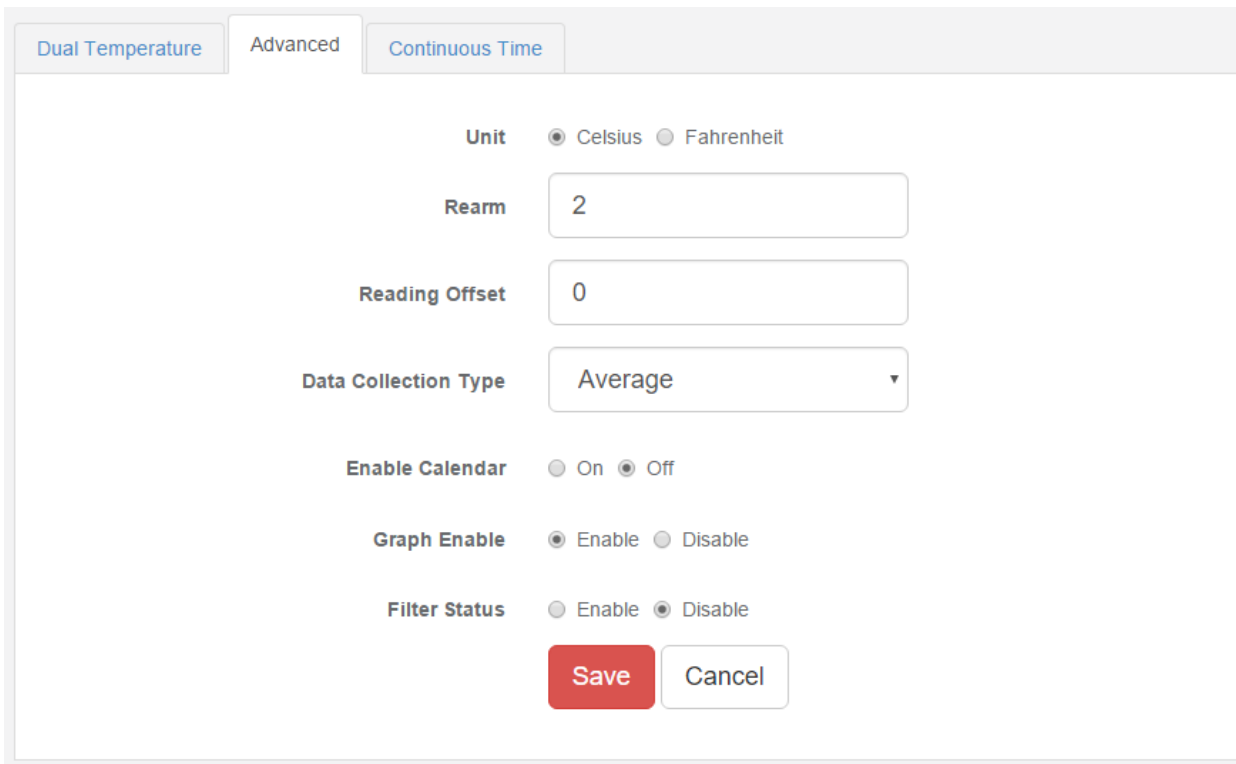

The screenshot shows a web-based configuration interface for sensors. At the top, there are three tabs: 'Dual Temperature', 'Advanced', and 'Continuous Time'. The 'Advanced' tab is selected. Below the tabs, there are several settings:

- Unit:** Radio buttons for 'Celsius' (selected) and 'Fahrenheit'.
- Rarm:** A text input field containing the value '2'.
- Reading Offset:** A text input field containing the value '0'.
- Data Collection Type:** A dropdown menu with 'Average' selected.
- Enable Calendar:** Radio buttons for 'On' and 'Off' (selected).
- Graph Enable:** Radio buttons for 'Enable' (selected) and 'Disable'.
- Filter Status:** Radio buttons for 'Enable' and 'Disable' (selected).

At the bottom of the configuration area, there are two buttons: a red 'Save' button and a white 'Cancel' button.

*Units:* changes units from °C to °F or vice versa.

*Rearm:* The Rearm parameter is useful for sensors whose values can vary such as the temperature and humidity sensors.

It is used to prevent the sensor from rapidly changing between two states. For example if the **Warning High** threshold for the temperature sensor is set to 80 degrees and the sensor were to vary between 79 and 80 you could be faced with a very large number of emails, traps, and events logged. The Rearm parameter prevents this by forcing the temperature to drop by the Rearm value before changing the state back to normal. In this example, if Rearm is set to 2 then the sensor would have to drop from 80 down to 77 before the status would change from **Warning High** back to normal.

*Reading Offset:* The Reading Offset feature is a calibration tool. If you wish to calibrate the temperature sensor, for example, you could enter an offset value of 5. This would mean if the sensor reads 20 degrees then it would record as 25 degrees. This figure can also be a minus figure (e.g. -5 would show 15 degrees instead of 20).

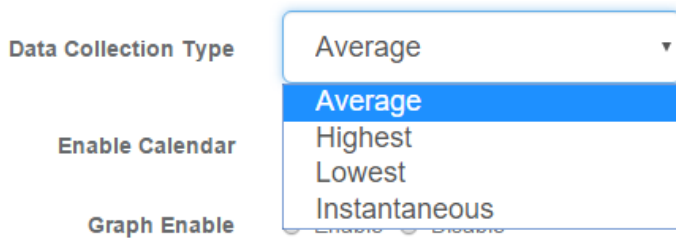

**Data Collection Type:** This refers to the data collection from the sensor and how the data is then displayed on the graphs.

There are four options for the collection of data: Average, Highest, Lowest and Instantaneous. The default setting is “Average”.

When the data collection type is set to “Average” the averaged value between 2 graph intervals is stored and output graphs for the daily, monthly, and yearly all have the same size on the screen. For the daily graph, each data point on the graph is one data point collected from the sensor. But for the monthly and yearly graph, in order to display more data into the same size as the daily graph, some consolidation on the data is needed. One data point on the monthly and yearly graph is an average of the sensor data in a range.

The maximum and minimum values showing on the monthly and yearly graphs are the value of this consolidated data and not the raw data over that period of that time.

When the Data Collection Type is set to the Highest setting then you will get the graphing output displaying the sensors highest average readings during sampling. This is the same for the Lowest setting (lowest average).

With the Instantaneous setting you can store the actual value of the sensor at the sampling interval without averaging.

**Graph Enable:** In order to save the data from the sensors on the unit you will need to enable the Graphing feature on the unit. You need to change the Enable Graph to the On position and click on the Save button to enable the graphing. Note that you could also enable the graphing from the Summary page.

**Filter Status:** The Sensor Filter Status is a feature that you can Enable or Disable and when enabled will check the sensor status. If the status of the sensor changes very rapidly, then it will report how many times the sensor status changed, instead of having multiple separate entries in the syslog. When enabled, this will report the changes and status of a sensor only once.

## Relay Sensor

Click on the sensor port where the sensor is connected to open the sensor's configuration.

*Note:* another way of accessing this page is to click on the sensor from the Summary page.

You can directly see the Relay's current status below the sensor port.

The screenshot shows a dashboard with four sensor ports labeled 1, 2, 3, and 4. Port 1 is a Temperature sensor with a 'Sensor Error' status. Port 2 is 'N/C' (Not Connected). Port 3 is a Relay sensor, currently 'Off', and is highlighted with a blue box. Port 4 is 'N/C'. Below this is the configuration page for 'Relay Port 3', which includes fields for Sensor Name, Sensor Status (Off), Sensor Currently (Online), Boot Up State (On/Off), and custom descriptions for Off and On states with color pickers. 'Save' and 'Cancel' buttons are at the bottom.

*Boot Up State:* You can change the state of the relay when the unit starts. The default is Off.

*Description of Status When Relay Off/On:* These fields are the custom description, which will be displayed in the Relay Status field when the relay state is off/on. The same text is listed as one of the relay actions used to turn off/on the relay. Examples for this field are Close/Open Door, Turn Pump Off/On, Turn Light Off/On, etc.

*Color:* You could assign a custom color for the Off/On status: click on the color and the color picker will be shown.



### Advanced sensor configuration for Relay sensors

#### Sensor Control:

This button allows you to manually control the relay by controlling the cycle of the relay in an on-off-on or an off-on-off cycle. You can also set the “Toggle” (Cycle Time) here in seconds.

You don't need to change an option to be able to link the relay to an action.

The following actions can be chosen in an action: Turn on until sensor normal, turn off until sensor normal, cycle the relay, turn on until acknowledged, and turn off until acknowledged.

We'll explain more about these options in the Notifications manual.

*Enable Calendar:* Allows you to setup a *Calendar Profile* for what days and times you want or do not want the relay to be active.

Enable Calendar  On  Off

Calendar Profile

Calendar #1

Edit

Click on the **Edit** button next to a selected calendar to modify it.

Calendar Filter

Calendar Name: Calendar #1

All	AM											PM												
	12	1	2	3	4	5	6	7	8	9	10	11	12	1	2	3	4	5	6	7	8	9	10	11
Sunday	Blue	Blue	Blue	Blue	Blue	Blue	Blue	Blue	Blue	Blue	Blue	Blue	Blue	Blue	Blue	Blue	Blue	Blue	Blue	Blue	Blue	Blue	Blue	Blue
Monday	Blue	Blue	Blue	Blue	Blue	Blue	Blue	Blue	Blue	Blue	Blue	Blue	Blue	Blue	Blue	Blue	Blue	Blue	Blue	Blue	Blue	Blue	Blue	Blue
Tuesday	Blue	Blue	Blue	Blue	Blue	Blue	Blue	Blue	Blue	Blue	Blue	Blue	Blue	Blue	Blue	Blue	Blue	Blue	Blue	Blue	Blue	Blue	Blue	Blue
Wednesday	Blue	Blue	Blue	Blue	Blue	Blue	Blue	Blue	Blue	Blue	Blue	Blue	Blue	Blue	Blue	Blue	Blue	Blue	Blue	Blue	Blue	Blue	Blue	Blue
Thursday	Blue	Blue	Blue	Blue	Blue	Blue	Blue	Blue	Blue	Blue	Blue	Blue	Blue	Blue	Blue	Blue	Blue	Blue	Blue	Blue	Blue	Blue	Blue	Blue
Friday	Blue	Blue	Blue	Blue	Blue	Blue	Blue	Blue	Blue	Blue	Blue	Blue	Blue	Blue	Blue	Blue	Blue	Blue	Blue	Blue	Blue	Blue	Blue	Blue
Saturday	Blue	Blue	Blue	Blue	Blue	Blue	Blue	Blue	Blue	Blue	Blue	Blue	Blue	Blue	Blue	Blue	Blue	Blue	Blue	Blue	Blue	Blue	Blue	Blue

\* To select a minute, right click at a cell. Working Hours / Inverse All

Close Save changes

Blue cells means that the notification is on, white cells means it's off.

All	AM											PM												
	12	1	2	3	4	5	6	7	8	9	10	11	12	1	2	3	4	5	6	7	8	9	10	11
Sunday																								
Monday																								
Tuesday																								
Wednesday																								
Thursday																								
Friday																								
Saturday																								

0	1	2	3	4	5	6	7	8	9
10	11	12	13	14	15	16	17	18	19
20	21	22	23	24	25	26	27	28	29
30	31	32	33	34	35	36	37	38	39
40	41	42	43	44	45	46	47	48	49
50	51	52	53	54	55	56	57	58	59

On 
Off

\* To select a minute, right click at a cell.

Working Hours / Inverse All

You can quickly select the Working Hours only, and specify a custom schedule down to minutes by right clicking on a cell.

## Pulse Counter sensor

1  
Auto Sense  
Pulse Counter  
Low Critical

2  
Auto Sense  
Dual Humidity  
Normal

3  
Auto Sense  
Dual Humidity  
Normal

Pulse Counter | Advanced | Continuous Time | Status Text

Sensor Name: Pulse Counter Port 1

Sensor Status: Low Critical

Sensor Reading: 0 Unit

Last Reset: N/A [Reset]

Sensor Currently: Online

0 → 10 (Low Critical) → 20 (Low Warning) → 40 (Normal) → 50 (High Warning) → 100 (High Critical)

[Save] [Cancel]

The pulse counter is available on the SP+ platform, as of firmware version 1.0.4967. It provides:

- accumulated pulse count
- flow conversion of the pulse count

It can measure up to 1000 pulses / sec (1 Kilohertz).

Normally this sensor should be used with some external sensor which outputs pulses.

Sensors that could work: basically any switch type sensor, and any custom sensor that could generate a pulse signal. For example Wind speed sensor, Electricity meter etc.

For example, you can connect the output of a third-party water flow sensor in the market to our sensor port.

The specs of those sensors will indicate how many pulses equal to, for example 1 liter: 100 pulses = 1 Liter.

Then you can set the "Number of Pulses per Unit" to 100, and change the unit to L.

Then the sensor value will be changed according to the output of the water flow sensor which is connected to the sensor port.

### How to use the pulse counter?

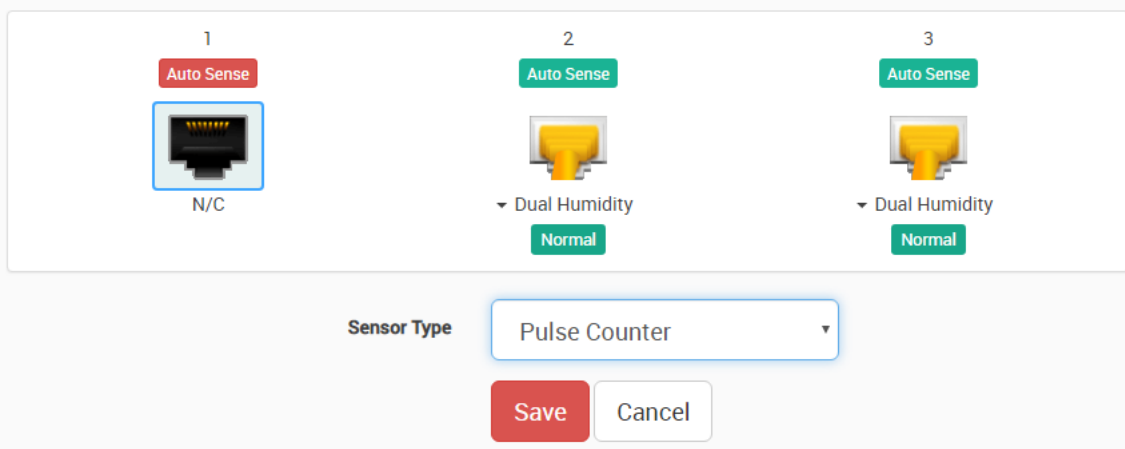

The sensor is designed to be used by disabling the Autosense and connecting an external sensor to the sensor port. This sensor will detect changes on the Data pin (Pin 1 of Sensor Port).

If there's changes:

- Flow Sensor value will show rate of the change in Unit / Second
- Pulse Counter will accumulate the pulses since the sensor is set to online

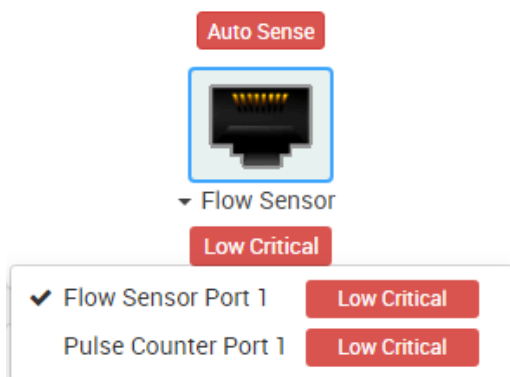

To set it up, disable Auto Sense on a sensor port and select the Pulse Counter sensor type from the list. This will give a dual sensor with Flow Sensor and Pulse Counter.

Flow Sensor   Advanced   Continuous Time   Status Text

**Edge Detection Mode**

**Unit**

**Number of Pulse per Unit**

**Time Period**

**Rearm**

**Calibration Factor**

**Min Value**

**Max Value**

**Enable Calendar**  On  Off

**Graph Enable**  Enable  Disable

**Filter Status**  Enable  Disable

In the Flow Sensor there is "Number of Pulse per Unit" in the config.  
You can use this value to adjust the sensor reading to match the real-world value.

Dry contact will also work but only to count the pulses. If you want to test for the rate accuracy, you'd have to test with something that can generate a wave signal, like using an oscilloscope to generate wave form and plug it to the sensor port.

But the general idea of this sensor is that it will show the rate of received pulses and also count it.

## Firmware upgrade through the Web UI

The firmware upgrade process is very simple and straight-forward.

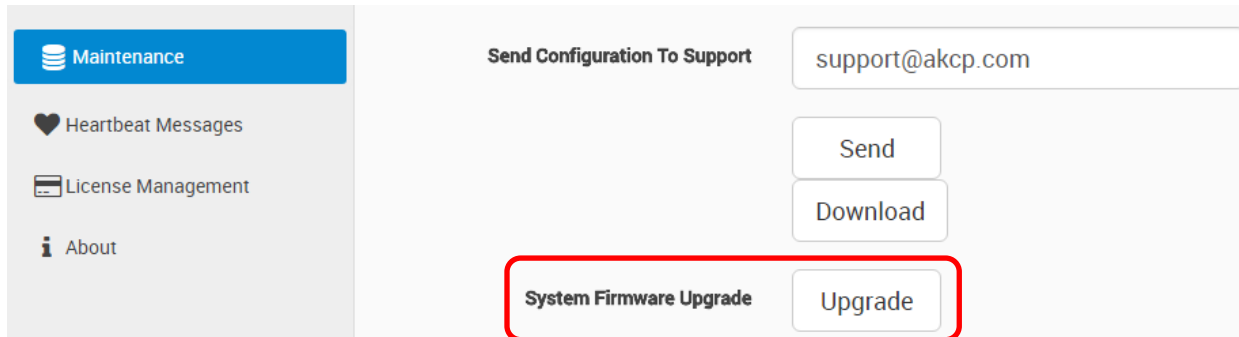

Open the **System/Maintenance** page and click on the **Upgrade** button at the System Firmware Upgrade section.

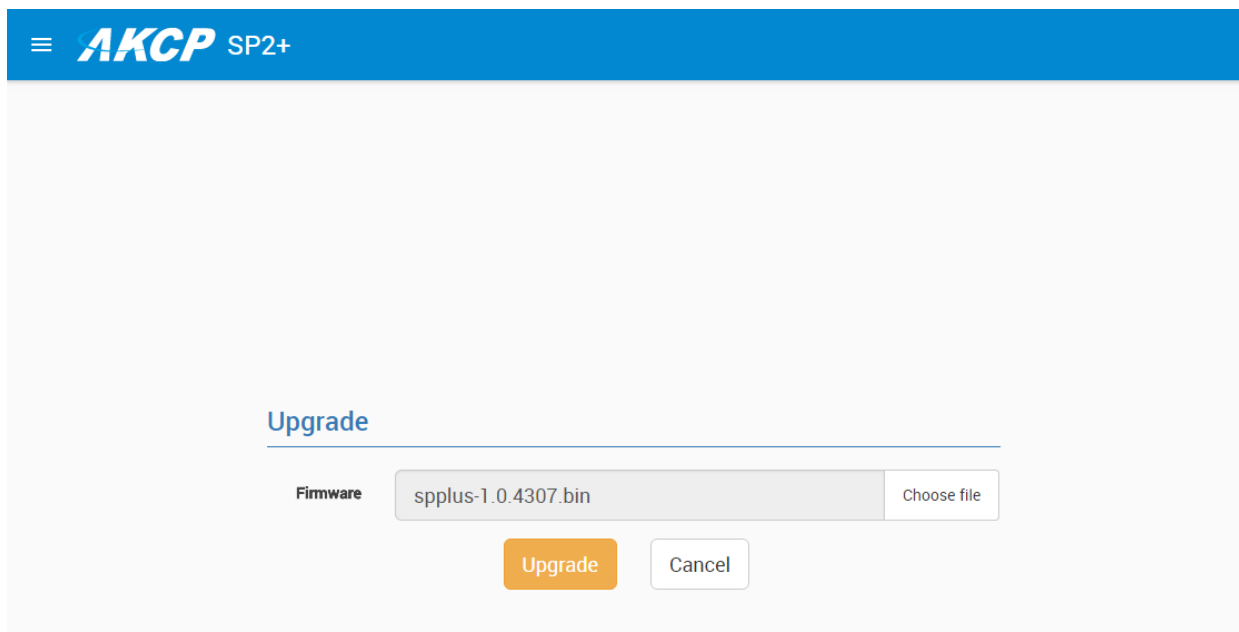

This will load the Upgrade page. Choose the firmware file from your PC and click on **Upgrade** to start the process.

**Important:** There are two separate .bin files included in a firmware update package. One for the F4 units and one for the F7 units. The .bin file for the F4 units is named spplus-1.0.xxxx.bin and the .bin file for the F7 units is named spplus\_f7-1.0.xxxx.bin. If you try to upgrade your unit with the wrong .bin file, the firmware upgrade will fail, so please make sure you use the correct file for your unit type.

### Uploading...



First the file will be uploaded to the unit...

### Upgrading..

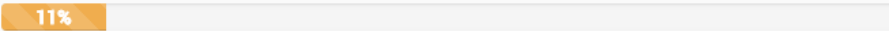

...then the upgrade process will run. The whole process can be done in a few minutes. The Power/Ethernet LED will be red during the upgrade.

### Upgrade Completed



Refresh

The unit will reboot at the end of the upgrade. Click on the **Refresh** button to reload the Web UI.



## Network ports used by SP+ units

Below we list the ports used by our SP+ units. Most of them are needed for external communications with APS, and to use network features.

Most ports are user configurable, these are the default ports.

### Main ports:

- 5000 TCP for RPC with APS - note: not fully user configurable
- 161 TCP/UDP for SNMP
- 80 TCP for HTTP of Web UI

### Other ports:

- 123 TCP for NTP (Network Time Protocol) - note: port is not user configurable
- 162 TCP/UDP for SNMP Trap
- 25 TCP for Email SMTP (if used)
- 1194 TCP/UDP for VPN (if used)
- 443 TCP for HTTPS of Web UI
- 502 TCP for Modbus TCP (if used)



Please contact [support@akcp.com](mailto:support@akcp.com) if you have any further technical questions or problems.

**Thanks for Choosing AKCP!**